

BROCAS METAL

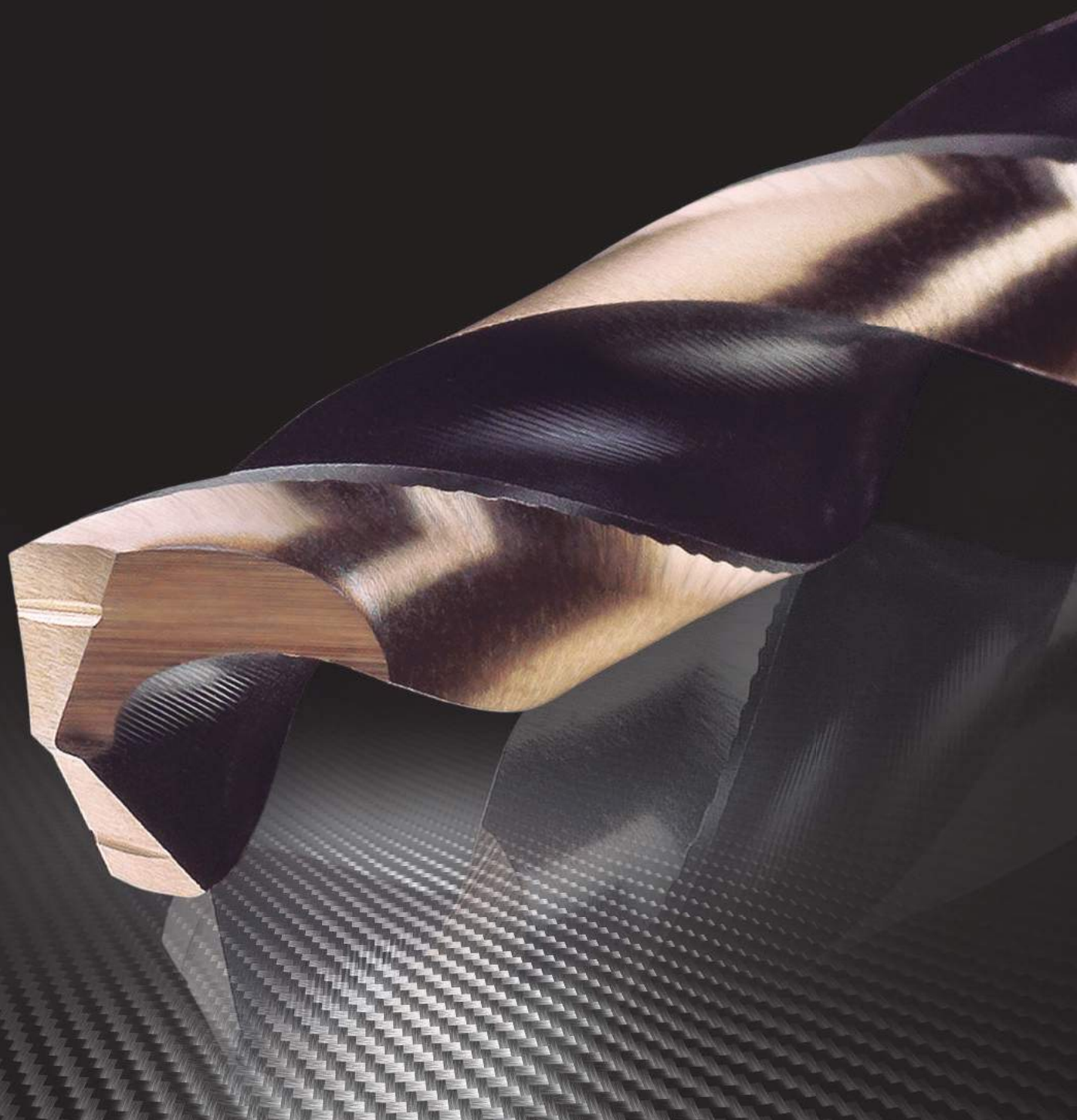

BROCAS HELICOIDALES CON MANGO CILÍNDRICO DIN 338



10 U. Ø 0,20 - Ø 10,50 mm

6 U. Ø 10,60 - Ø 14 mm

1 U. Ø 14,10 - Ø 20 mm

1 U. BC9-BC99
BC7-BC98-BC42



Brocas Metal

Rosa

	BC01	BC51	BC05	BC50	BC95	BC55	BC57	BC7	BC98	BC42
MATERIAL	HSS	HSSCo 5%	HSSCo 5%	HSSCo 5%	HSSCo 5%	HSSCo 5%	HSSCo 5%	PMD	PMD	MD
AFILADO										
ÁNGULO PUNTA	118°	135°	135°	118°	130°	135°	135°	118°	135°	135°
HÉLICE										
ACABADO	TIN	TiAIN	TiAISIN	TiAIN	DORADO OX	BRILLANTE	TiAIN	BRILLANTE	BRILLANTE	BRILLANTE
APLICACIÓN	PRODUCCIÓN	ALTA PRODUCCIÓN	ALTA PRODUCCIÓN	INOX Plus	INOX	INOX	INOX	FUNDICIÓN	70 HRc	ALTA PRODUCCIÓN
Ø mm	L1 x L2	€	€	€	€	€	€	€	€	€
0,20	19 x 2,50									
0,25	19 x 3									
0,30	19 x 3									
0,35	19 x 4									
0,40	20 x 5									
0,45	20 x 5									
0,50	22 x 6									13,27
0,55	24 x 7									
0,60	24 x 7									
0,65	26 x 8									
0,70	28 x 9									
0,75	28 x 9									
0,80	30 x 10									
0,85	30 x 10									
0,90	32 x 11									
0,95	32 x 11									
1,00	34 x 12	2,52	2,87	3,72		2,46	3,48	4,95		8,35
1,05	34 x 12									
1,10	36 x 14									
1,15	36 x 14									
1,19	3/64"								2,38	
1,20	38 x 16						4,59	4,75		
1,25	38 x 16									
1,30	38 x 16									
1,35	40 x 18									
1,40	40 x 18									
1,45	40 x 18									
1,50	40 x 18	2,57	2,71	3,45		2,35	3,38	4,94		9,30
1,55	43 x 20									

Ø 0,20-1,55mm

BROCAS HELICOIDALES CON MANGO CILÍNDRICO DIN 338

Brocas Metal

Gris
Rosa
**DIN
338**

		BC2	BC82	BC02	BC9	BC5	BC99	BC58	BC16	BC66	BC15	BC18
MATERIAL		HSS	HSS	HSS-G	HSS	HSSCo 5%	HSSCo 5%	HSSCo 8%	HSS	HSS	HSS	HSS
AFILADO												
ÁNGULO PUNTA		118°	118°	118°	118°	135°	135°	135°	135°	118°	118°	118°
HÉLICE		30° "N"	30° "N"	30° "N"	30° "N"	30° "N"	30° "N"	30° "N"	40° "W"	15° "H"	30° "N"	30° "N"
ACABADO		OX	BRILLANTE	DORADO OX	OX	DORADO	DORADO	DORADO	BRILLANTE	BRILLANTE	OX	TiN
APLICACIÓN									Al	LATÓN		PRODUCCIÓN
Ø mm	L1 x L2	€	€	€	€	€	€	€	€	€	€	€
1,59	1/16"	1,24				2,23						
1,60	43 x 20	1,30	1,30			2,34						1,87
1,65	43 x 20	1,30	1,30									
1,70	43 x 20	1,30	1,30			2,34						1,86
1,75	46 x 22	1,17	1,17			2,28		3,35	2,30	3,73		1,79
1,80	46 x 22	1,17	1,17			2,34						1,75
1,85	46 x 22	1,17	1,17									
1,90	46 x 22	1,17	1,17			2,34						1,75
1,95	48 x 24	1,17										
1,98	5/64"	1,11				2,33						
2,00	49 x 24	1,00	1,00	1,10		1,92		2,77	1,88	2,20	3,15	1,65
2,05	49 x 24	1,13	1,13									
2,10	49 x 24	1,13	1,13			2,47						1,76
2,15	53 x 27	1,13										
2,20	53 x 27	1,13	1,13			2,47						1,75
2,25	53 x 27	1,05	1,05	1,17		2,34		3,35	2,28	2,55		1,69
2,30	53 x 27	1,30	1,30			2,47						1,87
2,35	53 x 27	1,30	1,30									
2,38	3/32"	1,24				2,33						
2,40	57 x 30	1,30	1,30			2,47						1,87
2,45	57 x 30	1,30										
2,50	57 x 30	1,10	1,10	1,23		1,92		2,77	1,89	2,23	3,15	1,76
2,55	57 x 30	1,33	1,33									
2,60	57 x 30	1,33	1,33			2,37						1,86
2,65	57 x 30	1,33										
2,70	61 x 33	1,33	1,33	1,49		2,37						1,86
2,75	61 x 33	1,17	1,17	1,27		2,34		3,35	2,28	2,99		1,82
2,78	7/64"	1,27				2,27						
2,80	61 x 33	1,33	1,33	1,49		2,38						1,86

BROCAS HELICOIDALES CON MANGO CILÍNDRICO DIN 338



- 10 U.** Ø 0,20 - Ø 10,50 mm
- 6 U.** Ø 10,60 - Ø 14 mm
- 1 U.** Ø 14,10 - Ø 20 mm
- 1 U.** BC9-BC99
BC7-BC98-BC42



Brocas Metal

Rosa

		BC01	BC51	BC05	BC50	BC95	BC55	BC57	BC7	BC98	BC42
MATERIAL		HSS	HSSCo 5%	HSSCo 5%	HSSCo 5%	HSSCo 5%	HSSCo 5%	HSSCo 5%	PMD	PMD	MD
AFILADO											
ÁNGULO PUNTA		118°	135°	135°	118°	130°	135°	135°	118°	135°	135°
HÉLICE		30° "N"	30° "N"	30° "N"	38° "N"	Ø ≥ 3	38° "S"	38° "S"	30° "N"	30° "N"	35° "N"
ACABADO		TIN	TiAIN	TiAISIN	TiAIN	DORADO OX	BRILLANTE	TiAIN	BRILLANTE	BRILLANTE	BRILLANTE
APLICACIÓN		PRODUCCIÓN	ALTA PRODUCCIÓN	ALTA PRODUCCIÓN	INOX Plus	INOX	INOX	INOX	FUNDICIÓN	70 HRc	ALTA PRODUCCIÓN
Ø mm	L1 x L2	€	€	€	€	€	€	€	€	€	€
1,59	1/16"										
1,60	43 x 20						3,83				
1,65	43 x 20										
1,70	43 x 20						3,25				
1,75	46 x 22										
1,80	46 x 22						3,41	4,87			
1,85	46 x 22										
1,90	46 x 22						3,74				
1,95	48 x 24										
1,98	5/64"										
2,00	49 x 24	1,79	2,83	3,53	4,26	2,35	3,14	4,65	16,76		11,53
2,05	49 x 24										
2,10	49 x 24						3,50		17,69		16,18
2,15	53 x 27										
2,20	53 x 27						3,54	5,26	17,69		17,39
2,25	53 x 27								17,69		
2,30	53 x 27						3,47		17,69		17,39
2,35	53 x 27										
2,38	3/32"										
2,40	57 x 30						3,55		17,69		17,70
2,45	57 x 30										
2,50	57 x 30	1,92	2,82	3,60	4,31	2,35	3,14	4,65	16,76		13,97
2,55	57 x 30										
2,60	57 x 30						3,81		17,69		21,84
2,65	57 x 30										
2,70	61 x 33						3,63		16,85		21,84
2,75	61 x 33		2,95						17,69		
2,78	7/64"										
2,80	61 x 33						3,93	7,52	17,69		21,84

Ø 1,59-2,80mm

BROCAS HELICOIDALES CON MANGO CILÍNDRICO DIN 338

Brocas Metal

Gris
Rosa
**DIN
338**

		BC2	BC82	BC02	BC9	BC5	BC99	BC58	BC16	BC66	BC15	BC18
MATERIAL		HSS	HSS	HSS-G	HSS	HSSCo 5%	HSSCo 5%	HSSCo 8%	HSS	HSS	HSS	HSS
AFILADO												
ÁNGULO PUNTA		118°	118°	118°	118°	135°	135°	135°	135°	118°	118°	118°
HÉLICE		30° "N"	30° "N"	30° "N"	30° "N"	30° "N"	30° "N"	30° "N"	40° "W"	15° "H"	30° "N"	30° "N"
ACABADO		OX	BRILLANTE	DORADO OX	OX	DORADO	DORADO	DORADO	BRILLANTE	BRILLANTE	OX	TiN
APLICACIÓN									Al	LATÓN		PRODUCCIÓN
Ø mm	L1 x L2	€	€	€	€	€	€	€	€	€	€	€
2,85	61 x 33	1,34										
2,90	61 x 33	1,33	1,33			2,37						1,86
2,95	61 x 33	1,33										
3,00	61 x 33	1,00	1,00	1,10		1,88		2,68	1,87	2,45	2,74	1,65
3,05	65 x 36	1,30										
3,10	65 x 36	1,17	1,17	1,26		2,29		3,59				2,08
3,15	65 x 36	1,30										
3,17	1/8"	1,11				2,17						
3,20	65 x 36	1,17	1,17	1,26		2,28		3,59	2,28			2,08
3,25	65 x 36	1,17	1,17	1,26		2,29		3,29	2,28	2,99		2,08
3,30	65 x 36	1,17	1,17	1,26		2,28		3,59	2,28			2,08
3,35	65 x 36	1,49										
3,40	70 x 39	1,49	1,49	1,65		2,38						2,24
3,45	70 x 39	1,50										
3,50	70 x 39	1,13	1,13	1,26		2,28		3,23	2,24	2,65	3,26	2,06
3,55	70 x 39	1,56										
3,57	9/64"	1,46				2,72						
3,60	70 x 39	1,56	1,56	1,73		2,86						2,27
3,65	70 x 39	1,56										
3,70	70 x 39	1,56	1,56	1,73		2,86						2,26
3,75	70 x 39	1,30	1,30	1,49		2,71		3,91	2,79	3,90		2,20
3,80	75 x 43	1,60	1,60	1,82		2,86						2,29
3,85	75 x 43	1,61										
3,90	75 x 43	1,59	1,59	1,82		2,86						2,28
3,95	75 x 43	1,59										
3,97	5/32"	1,51				2,72						
4,00	75 x 43	1,26	1,26	1,44		2,42		3,50	2,42	2,85	3,56	2,15
4,05	75 x 43	1,59										
4,10	75 x 43	1,43	1,43	1,59		2,71		4,31	2,75			2,25

BROCAS HELICOIDALES CON MANGO CILÍNDRICO DIN 338



- 10 U.** Ø 0,20 - Ø 10,50 mm
- 6 U.** Ø 10,60 - Ø 14 mm
- 1 U.** Ø 14,10 - Ø 20 mm
- 1 U.** BC9-BC99
BC7-BC98-BC42



Brocas Metal
Rosa

		BC01	BC51	BC05	BC50	BC95	BC55	BC57	BC7	BC98	BC42
MATERIAL		HSS	HSSCo 5%	HSSCo 5%	HSSCo 5%	HSSCo 5%	HSSCo 5%	HSSCo 5%	PMD	PMD	MD
AFILADO											
ÁNGULO PUNTA		118°	135°	135°	118°	130°	135°	135°	118°	135°	135°
HÉLICE		30° "N"	30° "N"	30° "N"	38° "N"	Ø ≥ 3	38° "S"	38° "S"	30° "N"	30° "N"	35° "N"
ACABADO		TIN	TiAIN	TiAISIN	TiAIN	DORADO OX	BRILLANTE	TiAIN	BRILLANTE	BRILLANTE	BRILLANTE
APLICACIÓN		PRODUCCIÓN	ALTA PRODUCCIÓN	ALTA PRODUCCIÓN	INOX Plus	INOX	INOX	INOX	FUNDICIÓN	70 HRc	ALTA PRODUCCIÓN
Ø mm	L1 x L2	€	€	€	€	€	€	€	€	€	€
2,85	61 x 33										
2,90	61 x 33						3,96		17,69		21,84
2,95	61 x 33										
3,00	61 x 33	1,79	2,78	3,55	4,75	2,30	3,07	4,56	16,36	12,51	14,33
3,05	65 x 36										
3,10	65 x 36						3,67	5,61	16,74		22,05
3,15	65 x 36										
3,17	1/8"										
3,20	65 x 36					2,84	3,67	5,65	16,74		22,05
3,25	65 x 36								16,91		
3,30	65 x 36	2,24	3,48	4,19	5,78	2,85	3,67	5,67	16,91	14,15	19,39
3,35	65 x 36										
3,40	70 x 39						4,28		16,91		24,18
3,45	70 x 39										
3,50	70 x 39	2,26	3,49	4,43	5,11	2,77	3,70	5,63	16,04	13,06	19,12
3,55	70 x 39										
3,57	9/64"										
3,60	70 x 39						4,28		16,74	14,15	25,34
3,65	70 x 39										
3,70	70 x 39						4,28		16,91		25,34
3,75	70 x 39								16,91		
3,80	75 x 43						4,88	8,10	16,91		26,57
3,85	75 x 43										
3,90	75 x 43						4,71		16,91		26,57
3,95	75 x 43										
3,97	5/32"										
4,00	75 x 43	2,39	3,57	4,52	5,79	3,02	3,98	5,88	16,20	12,71	21,50
4,05	75 x 43										
4,10	75 x 43						4,40	6,33	16,85		28,44

Ø 2,85-4,10mm

BROCAS HELICOIDALES CON MANGO CILÍNDRICO DIN 338

Brocas Metal

Gris
Rosa
**DIN
338**

		BC2	BC82	BC02	BC9	BC5	BC99	BC58	BC16	BC66	BC15	BC18
MATERIAL		HSS	HSS	HSS-G	HSS	HSSCo 5%	HSSCo 5%	HSSCo 8%	HSS	HSS	HSS	HSS
AFILADO												
ÁNGULO PUNTA		118°	118°	118°	118°	135°	135°	135°	135°	118°	118°	118°
HÉLICE		30° "N"	30° "N"	30° "N"	30° "N"	30° "N"	30° "N"	30° "N"	40° "W"	15° "H"	30° "N"	30° "N"
ACABADO		OX	BRILLANTE	DORADO OX	OX	DORADO	DORADO	DORADO	BRILLANTE	BRILLANTE	OX	TiN
APLICACIÓN				<i>Plus</i>					Al	LATÓN		PRODUCCIÓN
Ø mm	L1 x L2	€	€	€	€	€	€	€	€	€	€	€
4,15	75 x 43	1,59										
4,20	75 x 43	1,43	1,43	1,59		2,71		4,31	2,75			2,25
4,25	75 x 43	1,43	1,43	1,60		2,71		3,91	3,05	4,26		2,25
4,30	80 x 47	1,89	1,89	2,15		2,86						2,48
4,35	80 x 47	1,87										
4,37	11/64"	1,78				2,72						
4,40	80 x 47	1,89	1,89	2,15		2,86						2,48
4,45	80 x 47	1,89										
4,50	80 x 47	1,49	1,49	1,62		2,79		3,91	2,69	3,51	3,73	2,26
4,55	80 x 47	1,92										
4,60	80 x 47	1,92	1,92			3,19						2,51
4,65	80 x 47	1,92										
4,70	80 x 47	1,93	1,93	2,15		3,19						2,51
4,75	80 x 47	1,70	1,70	1,93		3,03		4,32	3,43	4,79		2,42
4,76	3/16"	1,62				2,83						
4,80	86 x 52	2,15	2,15	2,34		3,20		4,76				2,66
4,85	86 x 52	2,08										
4,90	86 x 52	2,08	2,08	2,30		3,20						2,63
4,95	86 x 52	2,09										
5,00	86 x 52	1,56	1,56	1,77		2,92		4,19	2,88	3,81	4,02	2,31
5,05	86 x 52	2,16	2,16									
5,10	86 x 52	2,15	2,15	2,37		3,51		5,13	3,49			2,65
5,15	86 x 52	2,16										
5,16	13/64"	2,06				2,99						
5,20	86 x 52	2,15	2,15	2,37		3,51		5,13				2,64
5,25	86 x 52	2,02	2,02	2,28		3,43		4,92	4,10	5,72		2,62
5,30	86 x 52	2,67	2,67	2,95		3,49						2,98
5,35	93 x 57	2,66										
5,40	93 x 57	2,67	2,67			3,51						2,98

BROCAS HELICOIDALES CON MANGO CILÍNDRICO DIN 338



- 10 U.** Ø 0,20 - Ø 10,50 mm
- 6 U.** Ø 10,60 - Ø 14 mm
- 1 U.** Ø 14,10 - Ø 20 mm
- 1 U.** BC9-BC99
BC7-BC98-BC42



Brocas Metal
Rosa

		BC01	BC51	BC05	BC50	BC95	BC55	BC57	BC7	BC98	BC42
MATERIAL		HSS	HSSCo 5%	HSSCo 5%	HSSCo 5%	HSSCo 5%	HSSCo 5%	HSSCo 5%	PMD	PMD	MD
AFILADO											
ÁNGULO PUNTA		118°	135°	135°	118°	130°	135°	135°	118°	135°	135°
HÉLICE		30° "N"	30° "N"	30° "N"	38° "N"	Ø ≥ 3	38° "S"	38° "S"	30° "N"	30° "N"	35° "N"
ACABADO		TIN	TiAIN	TiAISIN	TiAIN	DORADO OX	BRILLANTE	TiAIN	BRILLANTE	BRILLANTE	BRILLANTE
APLICACIÓN		PRODUCCIÓN	ALTA PRODUCCIÓN	ALTA PRODUCCIÓN	INOX Plus	INOX	INOX	INOX	FUNDICIÓN	70 HRc	ALTA PRODUCCIÓN
Ø mm	L1 x L2	€	€	€	€	€	€	€	€	€	€
4,15	75 x 43										
4,20	75 x 43	2,46	3,75	4,74	7,13	3,36	4,42	6,32	16,85	14,81	26,31
4,25	75 x 43		3,75	4,74					17,69		
4,30	80 x 47						4,72	6,76	17,69	14,81	32,88
4,35	80 x 47										
4,37	11/64"										
4,40	80 x 47						4,72		17,69	14,81	33,54
4,45	80 x 47										
4,50	80 x 47	2,46	3,82	4,65	6,68	3,36	4,54	6,46	16,54	12,22	26,29
4,55	80 x 47										
4,60	80 x 47						5,64		17,69		32,71
4,65	80 x 47										
4,70	80 x 47						5,24		17,19		32,71
4,75	80 x 47								17,69		
4,76	3/16"										
4,80	86 x 52						5,24	7,16	17,69		33,87
4,85	86 x 52										
4,90	86 x 52						5,78		17,69		33,87
4,95	86 x 52										
5,00	86 x 52	2,59	3,91	4,82	7,04	3,59	4,73	6,69	16,20	11,97	28,90
5,05	86 x 52										
5,10	86 x 52						5,65	7,52	18,14	14,65	38,04
5,15	86 x 52										
5,16	13/64"										
5,20	86 x 52						5,67	7,58	18,59		38,04
5,25	86 x 52								18,59		
5,30	86 x 52						5,65		18,59		38,04
5,35	93 x 57										
5,40	93 x 57						7,31		18,59		43,06

Ø 4,15-5,40mm

BROCAS HELICOIDALES CON MANGO CILÍNDRICO DIN 338

Brocas Metal

Gris
Rosa
**DIN
338**

		BC2	BC82	BC02	BC9	BC5	BC99	BC58	BC16	BC66	BC15	BC18
MATERIAL		HSS	HSS	HSS-G	HSS	HSSCo 5%	HSSCo 5%	HSSCo 8%	HSS	HSS	HSS	HSS
AFILADO												
ÁNGULO PUNTA		118°	118°	118°	118°	135°	135°	135°	135°	118°	118°	118°
HÉLICE		30° "N"	30° "N"	30° "N"	30° "N"	30° "N"	30° "N"	30° "N"	40° "W"	15° "H"	30° "N"	30° "N"
ACABADO		OX	BRILLANTE	DORADO OX	OX	DORADO	DORADO	DORADO	BRILLANTE	BRILLANTE	OX	TiN
APLICACIÓN				<i>Plus</i>					Al	LATÓN		PRODUCCIÓN
Ø mm	L1 x L2	€	€	€	€	€	€	€	€	€	€	€
5,45	93 x 57	2,67										
5,50	93 x 57	2,09	2,09	2,34		3,69		5,29	3,68	4,61	5,30	2,66
5,55	93 x 57	2,84										
5,56	7/32"	2,69				4,16						
5,60	93 x 57	2,85	2,85	3,14		4,37		6,53				3,10
5,65	93 x 57	2,84										
5,70	93 x 57	2,85	2,85	3,14		4,37		6,53				3,10
5,75	93 x 57	2,73	2,73	3,06		4,15		5,91	5,03	7,00		3,08
5,80	93 x 57	2,66	2,66	3,02		4,37		6,53				2,98
5,85	93 x 57	2,67										
5,90	93 x 57	2,66	2,66	3,00		4,37						2,98
5,95	15/64"	2,52				4,55						
6,00	93 x 57	2,19	2,19	2,42		3,92		5,63	3,89	5,00	5,48	2,71
6,05	101 x 63	3,07										
6,10	101 x 63	3,07	3,07	3,47		4,86						5,37
6,15	101 x 63	3,07										
6,20	101 x 63	3,07	3,07	3,47		4,86						5,37
6,25	101 x 63	2,89	2,89	3,23		4,58		6,59	5,03	7,00		5,37
6,30	101 x 63	3,22	3,22			4,86						5,44
6,35	1/4"	2,31				4,62						
6,40	101 x 63	3,34	3,34			4,87						5,58
6,45	101 x 63	3,24										
6,50	101 x 63	2,50	2,50	2,84		4,70		6,57	4,54	5,57	6,43	5,11
6,55	101 x 63	4,06										
6,60	101 x 63	4,01	4,01			5,86						6,01
6,65	101 x 63	4,06										
6,70	101 x 63	4,05	4,05	4,49		5,86		8,42				6,01
6,75	109 x 69	3,05	3,05	3,42		5,48		7,69	6,06	8,45		5,47
6,80	109 x 69	3,05	3,05	3,42		5,48		8,42	5,33			5,48

BROCAS HELICOIDALES CON MANGO CILÍNDRICO DIN 338



- 10 U.** Ø 0,20 - Ø 10,50 mm
- 6 U.** Ø 10,60 - Ø 14 mm
- 1 U.** Ø 14,10 - Ø 20 mm
- 1 U.** BC9-BC99
BC7-BC98-BC42



		BC01	BC51	BC05	BC50	BC95	BC55	BC57	BC7	BC98	BC42
MATERIAL		HSS	HSSCo 5%	HSSCo 5%	HSSCo 5%	HSSCo 5%	HSSCo 5%	HSSCo 5%	PMD	PMD	MD
AFILADO											
ÁNGULO PUNTA		118°	135°	135°	118°	130°	135°	135°	118°	135°	135°
HÉLICE		30° "N"	30° "N"	30° "N"	38° "N"	Ø ≥ 3	38° "S"	38° "S"	30° "N"	30° "N"	35° "N"
ACABADO		TIN	TiAIN	TiAISIN	TiAIN	DORADO OX	BRILLANTE	TiAIN	BRILLANTE	BRILLANTE	BRILLANTE
APLICACIÓN		PRODUCCIÓN	ALTA PRODUCCIÓN	ALTA PRODUCCIÓN	INOX Plus	INOX	INOX	INOX	FUNDICIÓN	70 HRc	ALTA PRODUCCIÓN
Ø mm	L1 x L2	€	€	€	€	€	€	€	€	€	€
5,45	93 x 57										
5,50	93 x 57	2,97	4,42	5,29	8,60	4,55	6,00	7,93	17,28	12,76	33,41
5,55	93 x 57										
5,56	7/32"										
5,60	93 x 57						7,16		19,44		45,23
5,65	93 x 57										
5,70	93 x 57						8,24		18,88		45,23
5,75	93 x 57						6,77		19,44		
5,80	93 x 57						7,16	9,08	18,88		45,23
5,85	93 x 57										
5,90	93 x 57						7,16		19,44		45,23
5,95	15/64"										
6,00	93 x 57	2,98	4,53	5,29	9,54	4,84	6,43	8,34	18,41	13,60	38,62
6,05	101 x 63										
6,10	101 x 63						8,93		19,89		56,02
6,15	101 x 63										
6,20	101 x 63						7,94	13,09	19,89		56,02
6,25	101 x 63							19,89			
6,30	101 x 63						8,93	19,89			56,02
6,35	1/4"										
6,40	101 x 63						8,93		19,89		56,02
6,45	101 x 63										
6,50	101 x 63	5,67	8,44	10,83	11,36	5,65	7,70	12,86	18,77	13,86	47,96
6,55	101 x 63										
6,60	101 x 63						10,11		21,05		69,65
6,65	101 x 63										
6,70	101 x 63						10,11		21,05		69,65
6,75	109 x 69		8,94	11,15					21,05		
6,80	109 x 69	5,86	8,94	11,15		6,64	8,97	14,14	21,65	16,59	56,23

Brocas Metal
Rosa

Ø 5,45-6,80mm

BROCAS HELICOIDALES CON MANGO CILÍNDRICO DIN 338

Brocas Metal

Gris
Rosa
**DIN
338**

		BC2	BC82	BC02	BC9	BC5	BC99	BC58	BC16	BC66	BC15	BC18
MATERIAL		HSS	HSS	HSS-G	HSS	HSSCo 5%	HSSCo 5%	HSSCo 8%	HSS	HSS	HSS	HSS
AFILADO												
ÁNGULO PUNTA		118°	118°	118°	118°	135°	135°	135°	135°	118°	118°	118°
HÉLICE		30° "N"	30° "N"	30° "N"	30° "N"	30° "N"	30° "N"	30° "N"	40° "W"	15° "H"	30° "N"	30° "N"
ACABADO		OX	BRILLANTE	DORADO OX	OX	DORADO	DORADO	DORADO	BRILLANTE	BRILLANTE	OX	TiN
APLICACIÓN				<i>Plus</i>					Al	LATÓN		PRODUCCIÓN
Ø mm	L1 x L2	€	€	€	€	€	€	€	€	€	€	€
6,85	109 x 69	4,47										
6,90	109 x 69	4,48	4,48			5,86						6,26
6,95	109 x 69	4,48										
7,00	109 x 69	3,05	3,05	3,42		5,17		6,88	4,96	5,86	7,78	5,48
7,05	109 x 69	4,71										
7,10	109 x 69	4,70	4,70			7,44						6,42
7,14	9/32"	4,50				7,02						
7,15	109 x 69	4,72										
7,20	109 x 69	4,70	4,70			7,44						6,42
7,25	109 x 69	3,88	3,88	4,31		7,01		9,35	8,01	11,18		6,00
7,30	109 x 69	4,71	4,71			7,45						6,42
7,35	109 x 69	4,70										
7,40	109 x 69	4,71	4,71	5,28		7,45						6,42
7,45	109 x 69	4,85										
7,50	109 x 69	3,22	3,22	3,60		5,49		7,34	5,26	6,92	8,17	5,60
7,54	19/64"	5,26				8,50						
7,55	117 x 75	5,58										
7,60	117 x 75	5,55	5,55			8,97						7,05
7,65	117 x 75	5,58										
7,70	117 x 75	5,55	5,55			8,94						7,05
7,75	117 x 75	4,28	4,28	4,79		8,49		11,33	10,19	14,91		6,41
7,80	117 x 75	5,63	5,63	6,33		8,94						7,07
7,85	117 x 75	5,64										
7,90	117 x 75	5,63	5,63	6,33		8,99						7,07
7,94	5/16"	4,81				8,48						
7,95	117 x 75	5,63										
8,00	117 x 75	3,70	3,70	4,15		6,44		8,60	6,18	7,35	9,35	5,86
8,05	117 x 75	5,78										
8,10	117 x 75	5,78	5,78			8,61						7,74

BROCAS HELICOIDALES CON MANGO CILÍNDRICO DIN 338



- 10 U.** Ø 0,20 - Ø 10,50 mm
- 6 U.** Ø 10,60 - Ø 14 mm
- 1 U.** Ø 14,10 - Ø 20 mm
- 1 U.** BC9-BC99
BC7-BC98-BC42



Brocas Metal
Rosa

	BC01	BC51	BC05	BC50	BC95	BC55	BC57	BC7	BC98	BC42	
MATERIAL	HSS	HSSCo 5%	HSSCo 5%	HSSCo 5%	HSSCo 5%	HSSCo 5%	HSSCo 5%	PMD	PMD	MD	
AFILADO											
ÁNGULO PUNTA	118°	135°	135°	118°	130°	135°	135°	118°	135°	135°	
HÉLICE	30° "N"	30° "N"	30° "N"	38° "N"	Ø ≥ 3	38° "S"	38° "S"	30° "N"	30° "N"	35° "N"	
ACABADO	TIN	TiAIN	TiAISIN	TiAIN	DORADO OX	BRILLANTE	TiAIN	BRILLANTE	BRILLANTE	BRILLANTE	
APLICACIÓN	PRODUCCIÓN	ALTA PRODUCCIÓN	ALTA PRODUCCIÓN	INOX Plus	INOX	INOX	INOX	FUNDICIÓN	70 HRc	ALTA PRODUCCIÓN	
Ø mm	L1 x L2	€	€	€	€	€	€	€	€	€	
6,85	109 x 69										
6,90	109 x 69										
6,95	109 x 69					10,21		21,05	16,59	69,65	
7,00	109 x 69	6,03	8,91	11,37	13,35	6,18	8,36	13,74	21,00	15,51	55,85
7,05	109 x 69										
7,10	109 x 69						12,36		22,69	17,87	79,66
7,14	9/32"										
7,15	109 x 69										
7,20	109 x 69						11,84	17,24	22,69		79,66
7,25	109 x 69							22,69			
7,30	109 x 69						12,60		22,69		79,66
7,35	109 x 69										
7,40	109 x 69						12,60		22,69		79,66
7,45	109 x 69										
7,50	109 x 69	6,15	9,15	11,84	15,37	6,56	8,93	14,32	22,08	16,30	59,65
7,54	19/64"										
7,55	117 x 75										
7,60	117 x 75						12,96		24,37		79,66
7,65	117 x 75										
7,70	117 x 75						14,42		24,37		79,66
7,75	117 x 75								24,37		
7,80	117 x 75						14,42	20,31	24,37		79,66
7,85	117 x 75										
7,90	117 x 75						14,42		24,37		79,66
7,94	5/16"										
7,95	117 x 75										
8,00	117 x 75	6,48	9,70	11,92	16,24	7,69	10,48	15,81	23,34	18,21	68,12
8,05	117 x 75										
8,10	117 x 75						15,19		26,03		92,67

Ø 6,85-8,10mm

BROCAS HELICOIDALES CON MANGO CILÍNDRICO DIN 338



- 10 U.** Ø 0,20 - Ø 10,50 mm
- 6 U.** Ø 10,60 - Ø 14 mm
- 1 U.** Ø 14,10 - Ø 20 mm
- 1 U.** BC9-BC99
BC7-BC98-BC42



Brocas Metal
Rosa

		BC01	BC51	BC05	BC50	BC95	BC55	BC57	BC7	BC98	BC42
MATERIAL		HSS	HSSCo 5%	HSSCo 5%	HSSCo 5%	HSSCo 5%	HSSCo 5%	HSSCo 5%	PMD	PMD	MD
AFILADO											
ÁNGULO PUNTA		118°	135°	135°	118°	130°	135°	135°	118°	135°	135°
HÉLICE		30° "N"	30° "N"	30° "N"	38° "N"	Ø ≥ 3	38° "S"	38° "S"	30° "N"	30° "N"	35° "N"
ACABADO		TIN	TiAIN	TiAISIN	TiAIN	DORADO OX	BRILLANTE	TiAIN	BRILLANTE	BRILLANTE	BRILLANTE
APLICACIÓN		PRODUCCIÓN	ALTA PRODUCCIÓN	ALTA PRODUCCIÓN	INOX Plus	INOX	INOX	INOX	FUNDICIÓN	70 HRc	ALTA PRODUCCIÓN
Ø mm	L1 x L2	€	€	€	€	€	€	€	€	€	€
8,15	117 x 75										
8,20	117 x 75						14,16	20,44	26,03		92,67
8,25	117 x 75								26,03		
8,30	117 x 75						15,05		26,03		92,67
8,33	21/64"										
8,35	117 x 75										
8,40	117 x 75						15,05		26,03		92,67
8,45	117 x 75										
8,50	117 x 75	7,35	10,86	13,80	19,90	8,02	10,85	17,18	24,66	18,21	80,56
8,55	125 x 81										
8,60	125 x 81						15,34		27,95	22,03	107,42
8,65	125 x 81										
8,70	125 x 81						17,84		27,95		107,42
8,73	11/32"										
8,75	125 x 81								27,95		
8,80	125 x 81						17,45	23,66	27,95		107,42
8,85	125 x 81										
8,90	125 x 81						17,84		27,95		107,42
8,95	125 x 81										
9,00	125 x 81	7,95	12,03	14,54	21,13	10,22	13,85	20,21	25,78	19,75	89,07
9,05	125 x 81										
9,10	125 x 81						21,96		30,22		118,01
9,13	23/64"										
9,15	125 x 81										
9,20	125 x 81						21,96	25,49	30,22		118,01
9,25	125 x 81								30,22		
9,30	125 x 81						21,96		30,22		118,01
9,35	125 x 81										
9,40	125 x 81						21,96		30,22		118,01
9,45	125 x 81										

Ø 8,15-9,45mm

BROCAS HELICOIDALES CON MANGO CILÍNDRICO DIN 338

Brocas Metal

Gris
Rosa
**DIN
338**

		BC2	BC82	BC02	BC9	BC5	BC99	BC58	BC16	BC66	BC15	BC18
MATERIAL		HSS	HSS	HSS-G	HSS	HSSCo 5%	HSSCo 5%	HSSCo 8%	HSS	HSS	HSS	HSS
AFILADO												
ÁNGULO PUNTA		118°	118°	118°	118°	135°	135°	135°	135°	118°	118°	118°
HÉLICE		30° "N"	30° "N"	30° "N"	30° "N"	30° "N"	30° "N"	30° "N"	40° "W"	15° "H"	30° "N"	30° "N"
ACABADO		OX	BRILLANTE	DORADO OX	OX	DORADO	DORADO	DORADO	BRILLANTE	BRILLANTE	OX	TiN
APLICACIÓN				<i>Plus</i>					Al	LATÓN		PRODUCCIÓN
Ø mm	L1 x L2	€	€	€	€	€	€	€	€	€	€	€
9,50	125 x 81	5,31	5,31	5,91		8,81		11,82	8,46	10,50	13,39	7,53
9,52	3/8"	4,96				8,39						
9,55	133 x 87	9,12										
9,60	133 x 87	9,01	9,01			14,19						9,92
9,65	133 x 87	9,12										
9,70	133 x 87	9,01	9,01			14,19						9,94
9,75	133 x 87	6,57	6,57	7,44		13,36		17,99	13,84	23,98		8,45
9,80	133 x 87	8,82	8,82			14,19						9,78
9,85	133 x 87	8,91										
9,90	133 x 87	8,91	8,91	10,03		14,19						9,78
9,92	25/64"	8,49				13,39						
9,95	133 x 87	8,90										
10,00	133 x 87	5,69	5,69	6,36	9,40	9,74		13,05	9,36	10,92	14,43	7,81
10,10	133 x 87	7,64	7,64	8,55		16,32						
10,20	133 x 87	7,09	7,09	7,93		13,75		23,60				13,58
10,25	133 x 87	7,92	7,92	9,82	12,40	16,83		23,60	15,36	26,81		13,78
10,30	133 x 87	8,91	8,91	9,92		16,35						
10,32	13/32"	8,49				15,50						
10,40	133 x 87	8,91	8,91			16,32						
10,50	133 x 87	7,07	7,07	7,92	10,58	13,76	20,46	19,20	12,49	13,12	19,72	12,89
10,60	133 x 87	9,78	9,78			18,97						
10,70	142 x 94	9,78	9,78			18,97						
10,72	27/64"	8,70				18,59						
10,75	142 x 94	9,14	9,14	10,11	14,02	19,71		27,46	17,97	24,48		14,22
10,80	142 x 94	10,84	10,84			18,97						
10,90	142 x 94	10,84	10,84			19,01						
11,00	142 x 94	8,26	8,26	9,26	11,93	15,20	21,85	21,18	13,56	14,60	23,74	13,62
11,10	142 x 94	11,06	11,06			21,65						
11,11	7 / 16"	10,53				20,42						
11,20	142 x 94	11,06	11,06			21,65						

BROCAS HELICOIDALES CON MANGO CILÍNDRICO DIN 338



- 10 U.** Ø 0,20 - Ø 10,50 mm
- 6 U.** Ø 10,60 - Ø 14 mm
- 1 U.** Ø 14,10 - Ø 20 mm
- 1 U.** BC9-BC99
BC7-BC98-BC42



		BC01	BC51	BC05	BC50	BC95	BC55	BC57	BC7	BC98	BC42
MATERIAL		HSS	HSSCo 5%	HSSCo 5%	HSSCo 5%	HSSCo 5%	HSSCo 5%	HSSCo 5%	PMD	PMD	MD
AFILADO											
ÁNGULO PUNTA		118°	135°	135°	118°	130°	135°	135°	118°	135°	135°
HÉLICE		30° "N"	30° "N"	30° "N"	38° "N"	Ø ≥ 3	38° "S"	38° "S"	30° "N"	30° "N"	35° "N"
ACABADO		TIN	TiAIN	TiAISIN	TiAIN	DORADO OX	BRILLANTE	TiAIN	BRILLANTE	BRILLANTE	BRILLANTE
APLICACIÓN		PRODUCCIÓN	ALTA PRODUCCIÓN	ALTA PRODUCCIÓN	INOX Plus	INOX	INOX	INOX	FUNDICIÓN	70 HRc	ALTA PRODUCCIÓN
Ø mm	L1 x L2	€	€	€	€	€	€	€	€	€	€
9,50	125 x 81	8,36	12,21	14,95	23,95	10,58	14,39	20,75	28,12	21,54	99,02
9,52	3/8"										
9,55	133 x 87										
9,60	133 x 87						21,96		32,41		125,16
9,65	133 x 87										
9,70	133 x 87						21,96		32,41		125,16
9,75	133 x 87								32,41		
9,80	133 x 87						21,85	28,15	32,41		125,16
9,85	133 x 87										
9,90	133 x 87						23,72		32,41		125,16
9,92	25/64"										
9,95	133 x 87										
10,00	133 x 87	8,52	12,80	15,34	26,41	11,64	15,86	22,10	28,18	22,10	107,05
10,10	133 x 87								36,31		
10,20	133 x 87	16,10	22,07	26,53	30,75	15,71	23,72	35,69	36,31	28,61	123,76
10,25	133 x 87								36,31		
10,30	133 x 87								36,31	28,61	
10,32	13/32"										
10,40	133 x 87								36,31		
10,50	133 x 87	16,03	22,05	26,70	31,19	15,72	22,48	35,12	36,04	28,39	118,60
10,60	133 x 87								38,62		
10,70	142 x 94								38,62		
10,72	27/64"										
10,75	142 x 94								38,62		
10,80	142 x 94						31,58		38,62		
10,90	142 x 94								38,62		
11,00	142 x 94	14,85	22,98	27,59	33,13	17,35	24,85	37,55	36,18	28,51	141,24
11,10	142 x 94								41,36		
11,11	7 / 16"										
11,20	142 x 94						38,34		41,36		

Brocas Metal

Rosa

Ø 9,50-11,20mm

BROCAS HELICOIDALES CON MANGO CILÍNDRICO DIN 338

Brocas Metal

Gris
Rosa
**DIN
338**

		BC2	BC82	BC02	BC9	BC5	BC99	BC58	BC16	BC66	BC15	BC18
MATERIAL		HSS	HSS	HSS-G	HSS	HSSCo 5%	HSSCo 5%	HSSCo 8%	HSS	HSS	HSS	HSS
AFILADO												
ÁNGULO PUNTA		118°	118°	118°	118°	135°	135°	135°	135°	118°	118°	118°
HÉLICE		30° "N"	30° "N"	30° "N"	30° "N"	30° "N"	30° "N"	30° "N"	40° "W"	15° "H"	30° "N"	30° "N"
ACABADO		OX	BRILLANTE	DORADO OX	OX	DORADO	DORADO	DORADO	BRILLANTE	BRILLANTE	OX	TiN
APLICACIÓN									Al	LATÓN		PRODUCCIÓN
Ø mm	L1 x L2	€	€	€	€	€	€	€	€	€	€	€
11,25	142 x 94	9,38	9,38	10,88	14,83	22,45		32,21	23,66	32,25		14,34
11,30	142 x 94	10,84	10,84			21,63						
11,40	142 x 94	10,84	10,84			21,65						
11,50	142 x 94	8,82	8,82	9,91	12,65	18,19	23,63	27,09	16,03	17,72	26,73	14,00
11,51	29/64"	8,40				17,24						
11,60	142 x 94	10,84	10,84			22,34						
11,70	142 x 94	10,84	10,84			22,34						
11,75	142 x 94	9,38	9,38	11,20	16,15	23,21		34,66	23,21	32,25		14,34
11,80	142 x 94	11,88	11,88			22,34						
11,90	151 x 101	11,88	11,88			22,34						
11,91	15/32"	11,31				21,18						
12,00	151 x 101	9,86	9,86	11,05	13,78	19,39	25,33	29,02	17,19	19,01	28,22	14,62
12,10	151 x 101	13,83	13,83			25,96						
12,20	151 x 101	13,83	13,83			25,96						
12,25	151 x 101	12,22	12,22	13,73	17,53	26,87		41,37	32,26	43,95		18,31
12,30	151 x 101	13,03	13,03			25,96						
12,40	151 x 101	13,03	13,03			25,96						
12,50	151 x 101	10,85	10,85	12,11	14,95	23,68	30,83	36,40	19,12	21,56	32,75	17,37
12,60	151 x 101	13,51	13,51			26,99						
12,70	1/2"	11,95				25,70						
12,75	151 x 101	12,01	12,01	13,72	18,07	28,04		43,20	35,61	48,81		18,17
12,80	151 x 101	15,07	15,07			26,99						
12,90	151 x 101	15,07	15,07			26,99						
13,00	151 x 101	11,19	11,19	12,47	15,37	24,23	32,53	36,92	19,40	23,19	35,59	17,64
13,10	151 x 101	15,42	15,42									
13,20	151 x 101	15,42	15,42									
13,25	160 x 108	17,60	17,60		21,97	33,54						
13,30	160 x 108	23,89	23,89									
13,40	160 x 108	23,89	23,89									
13,49	17/32"	15,11				25,43						

BROCAS HELICOIDALES CON MANGO CILÍNDRICO DIN 338



- 10 U.** Ø 0,20 - Ø 10,50 mm
- 6 U.** Ø 10,60 - Ø 14 mm
- 1 U.** Ø 14,10 - Ø 20 mm
- 1 U.** BC9-BC99
BC7-BC98-BC42



Brocas Metal
Rosa

		BC01	BC51	BC05	BC50	BC95	BC55	BC57	BC7	BC98	BC42
MATERIAL		HSS	HSSCo 5%	HSSCo 5%	HSSCo 5%	HSSCo 5%	HSSCo 5%	HSSCo 5%	PMD	PMD	MD
AFILADO											
ÁNGULO PUNTA		118°	135°	135°	118°	130°	135°	135°	118°	135°	135°
HÉLICE		30° "N"	30° "N"	30° "N"	38° "N"	Ø ≥ 3	38° "S"	38° "S"	30° "N"	30° "N"	35° "N"
ACABADO		TIN	TiAIN	TiAISIN	TiAIN	DORADO OX	BRILLANTE	TiAIN	BRILLANTE	BRILLANTE	BRILLANTE
APLICACIÓN		PRODUCCIÓN	ALTA PRODUCCIÓN	ALTA PRODUCCIÓN	INOX Plus	INOX	INOX	INOX	FUNDICIÓN	70 HRc	ALTA PRODUCCIÓN
Ø mm	L1 x L2	€	€	€	€	€	€	€	€	€	€
11,25	142 x 94								41,36		
11,30	142 x 94								41,36		
11,40	142 x 94								41,36		
11,50	142 x 94	15,37	24,40	28,72	38,00	19,97	29,60	41,84	41,59	32,76	156,02
11,51	29/64"										
11,60	142 x 94								45,61	35,93	
11,70	142 x 94								45,61		
11,75	142 x 94								45,61		
11,80	142 x 94						39,55		45,61		
11,90	151 x 101								45,61		
11,91	15/32"										
12,00	151 x 101	16,00	25,25	29,39	39,58	21,41	31,58	43,98	41,38	32,61	185,91
12,10	151 x 101								48,02	37,83	
12,20	151 x 101								48,02		
12,25	151 x 101								48,02		
12,30	151 x 101								48,02		
12,40	151 x 101								48,02		
12,50	151 x 101	18,84	31,20	36,32	44,80	23,86	38,47	47,55	49,61		254,00
12,60	151 x 101								50,73		
12,70	1/2"								50,73		
12,75	151 x 101								50,73		
12,80	151 x 101								50,73		
12,90	151 x 101								50,73		
13,00	151 x 101	18,70	31,67	36,71	48,21	24,21	39,54	54,93	49,52		201,02
13,10	151 x 101										
13,20	151 x 101										
13,25	160 x 108										
13,30	160 x 108										
13,40	160 x 108										
13,49	17/32"										

Ø 11,25-13,49mm

BROCAS HELICOIDALES CON MANGO CILÍNDRICO DIN 338

Brocas Metal

Gris
Rosa
**DIN
338**

		BC2	BC82	BC02	BC9	BC5	BC99	BC58	BC16	BC66	BC15	BC18
MATERIAL		HSS	HSS	HSS-G	HSS	HSSCo 5%	HSSCo 5%	HSSCo 8%	HSS	HSS	HSS	HSS
AFILADO												
ÁNGULO PUNTA		118°	118°	118°	118°	135°	135°	135°	135°	118°	118°	118°
HÉLICE		30° "N"	30° "N"	30° "N"	30° "N"	30° "N"	30° "N"	30° "N"	40° "W"	15° "H"	30° "N"	30° "N"
ACABADO		OX	BRILLANTE	DORADO OX	OX	DORADO	DORADO	DORADO	BRILLANTE	BRILLANTE	OX	TiN
APLICACIÓN				<i>Plus</i>					Al	LATÓN		PRODUCCIÓN
Ø mm	L1 x L2	€	€	€	€	€	€	€	€	€	€	€
13,50	160 x 108	15,87	15,87	17,80	20,49	26,70	34,89	40,69				21,52
13,60	160 x 108	23,89	23,89									
13,70	160 x 108	23,89	23,89									
13,75	160 x 108	17,80	17,80		23,56	33,54						
13,80	160 x 108	22,77	22,77									
13,89	35/64"	21,78				30,02						
13,90	160 x 108	22,87	22,87									
14,00	160 x 108	16,99	16,99	19,05	21,76	26,40	38,14	40,23				22,23
14,10	169 x 114	24,37										
14,20	169 x 114	24,37										
14,25	169 x 114	19,93	19,93		25,16	44,04						
14,29	9/16"	23,61				33,21						
14,30	169 x 114	24,79										
14,40	169 x 114	24,79										
14,50	169 x 114	18,36	18,36		23,53	37,44	48,75	57,04				23,05
14,60	169 x 114	25,25										
14,68	37/64"	18,98				41,94						
14,70	169 x 114	25,25										
14,75	169 x 114	19,93	19,93		28,89	44,04						
14,80	169 x 114	24,33										
14,90	169 x 114	24,33										
15,00	169 x 114	18,52	18,52	20,75	23,75	38,00	50,91	57,89				23,27
15,08	19/32"	17,64				36,19						
15,25	178 x 120	27,26			30,11	60,80						
15,48	39/64"	26,24				57,89						
15,50	178 x 120	21,69	21,69		27,43	43,95	56,81	66,94				25,30
15,75	178 x 120	27,55			31,20	60,78						
15,88	5/8"	21,47				43,45						
16,00	178 x 120	22,54	22,54		28,43	45,62	58,52	69,58				25,80
16,25	184 x 125	40,51			36,60							

BROCAS HELICOIDALES CON MANGO CILÍNDRICO DIN 338



- 10 U.** Ø 0,20 - Ø 10,50 mm
- 6 U.** Ø 10,60 - Ø 14 mm
- 1 U.** Ø 14,10 - Ø 20 mm
- 1 U.** BC9-BC99
BC7-BC98-BC42



		BC01	BC51	BC05	BC50	BC95	BC55	BC57	BC7	BC98	BC42
MATERIAL		HSS	HSSCo 5%	HSSCo 5%	HSSCo 5%	HSSCo 5%	HSSCo 5%	HSSCo 5%	PMD	PMD	MD
AFILADO											
ÁNGULO PUNTA		118°	135°	135°	118°	130°	135°	135°	118°	135°	135°
HÉLICE		30° "N"	30° "N"	30° "N"	38° "N"	Ø ≥ 3	38° "S"	38° "S"	30° "N"	30° "N"	35° "N"
ACABADO		TIN	TiAIN	TiAISIN	TiAIN	DORADO OX	BRILLANTE	TiAIN	BRILLANTE	BRILLANTE	BRILLANTE
APLICACIÓN		PRODUCCIÓN	ALTA PRODUCCIÓN	ALTA PRODUCCIÓN	INOX Plus	INOX	INOX	INOX	FUNDICIÓN	70 HRc	ALTA PRODUCCIÓN
Ø mm	L1 x L2	€	€	€	€	€	€	€	54,61	€	€
13,50	160 x 108										
13,60	160 x 108										
13,70	160 x 108										
13,75	160 x 108										
13,80	160 x 108										
13,89	35/64"										
13,90	160 x 108										
14,00	160 x 108								57,65		
14,10	169 x 114										
14,20	169 x 114										
14,25	169 x 114										
14,29	9/16"										
14,30	169 x 114										
14,40	169 x 114										
14,50	169 x 114								62,02		
14,60	169 x 114										
14,68	37/64"										
14,70	169 x 114										
14,75	169 x 114										
14,80	169 x 114										
14,90	169 x 114										
15,00	169 x 114								66,00		
15,08	19/32"										
15,25	178 x 120										
15,48	39/64"										
15,50	178 x 120								77,23		
15,75	178 x 120										
15,88	5/8"										
16,00	178 x 120								76,14		
16,25	184 x 125										

Brocas Metal

Rosa

Ø 13,50-16,25mm

BROCAS HELICOIDALES CON MANGO CILÍNDRICO DIN 338

Brocas Metal

Gris
Rosa
**DIN
338**

		BC2	BC82	BC02	BC9	BC5	BC99	BC58	BC16	BC66	BC15	BC18
MATERIAL		HSS	HSS	HSS-G	HSS	HSSCo 5%	HSSCo 5%	HSSCo 8%	HSS	HSS	HSS	HSS
AFILADO												
ÁNGULO PUNTA		118°	118°	118°	118°	135°	135°	135°	135°	118°	118°	118°
HÉLICE		30° "N"	30° "N"	30° "N"	30° "N"	30° "N"	30° "N"	30° "N"	40° "W"	15° "H"	30° "N"	30° "N"
ACABADO		OX	BRILLANTE	DORADO OX	OX	DORADO	DORADO	DORADO	BRILLANTE	BRILLANTE	OX	TiN
APLICACIÓN				<i>Plus</i>					Al	LATÓN		PRODUCCIÓN
Ø mm	L1 x L2	€	€	€	€	€	€	€	€	€	€	€
16,50	184 x 125	26,24	26,24		31,85	52,09	66,73					
16,75	184 x 125	42,44			35,91							
17,00	184 x 125	26,27	26,27		31,85	52,09	67,16					
17,25	191 x 130	44,03			40,44							
17,50	191 x 130	30,11	30,11		36,24	57,71	73,93					
17,75	191 x 130	48,76			42,65							
18,00	191 x 130	31,89	31,89		38,21	62,87	81,00					
18,25	198 x 135	47,84			52,05							
18,50	198 x 135	35,37	35,37		42,16	69,43	90,39					
18,75	198 x 135	49,16			48,15							
19,00	198 x 135	35,37	35,37		42,16	69,43	89,61					
19,25	205 x 140	64,24			51,40							
19,50	205 x 140	38,03	38,03		45,76	77,01	99,29					
19,75	205 x 140	62,53			57,56							
20,00	205 x 140	43,19	43,19		52,75	82,64	106,37					
20,50	205 x 140				61,19		126,64					
21,00	205 x 140				55,86		131,14					
21,50	209 x 140				64,96		152,51					
22,00	209 x 140				61,76		154,76					
22,50	214 x 140				66,06		165,52					
23,00	214 x 140				67,63		179,85					
23,50	220 x 145				75,08		199,65					
24,00	220 x 145				74,24		224,23					
24,50	225 x 150				79,98		241,58					
25,00	225 x 150				81,18		257,66					
26,00	243 x 157				97,38		262,46					
27,00	243 x 157				104,59		269,54					
28,00	253 x 167				108,21		296,94					
29,00	253 x 167				127,03		319,37					
30,00	258 x 171				133,53		330,55					

BROCAS HELICOIDALES CON MANGO CILÍNDRICO DIN 338



- 10 U.** Ø 0,20 - Ø 10,50 mm
- 6 U.** Ø 10,60 - Ø 14 mm
- 1 U.** Ø 14,10 - Ø 20 mm
- 1 U.** BC9-BC99
BC7-BC98-BC42



	BC01	BC51	BC05	BC50	BC95	BC55	BC57	BC7	BC98	BC42
MATERIAL	HSS	HSSCo 5%	HSSCo 5%	HSSCo 5%	HSSCo 5%	HSSCo 5%	HSSCo 5%	PMD	PMD	MD
AFILADO										
ÁNGULO PUNTA	118°	135°	135°	118°	130°	135°	135°	118°	135°	135°
HÉLICE	30° "N"	30° "N"	30° "N"	38° "N"	Ø ≥ 3	38° "S"	38° "S"	30° "N"	30° "N"	35° "N"
ACABADO	TIN	TiAIN	TiAISIN	TiAIN	DORADO OX	BRILLANTE	TiAIN	BRILLANTE	BRILLANTE	BRILLANTE
APLICACIÓN	PRODUCCIÓN	ALTA PRODUCCIÓN	ALTA PRODUCCIÓN	INOX Plus	INOX	INOX	INOX	FUNDICIÓN	70 HRC	ALTA PRODUCCIÓN
Ø mm	L1 x L2	€	€	€	€	€	€	€	€	€
16,50	184 x 125							107,23		
16,75	184 x 125									
17,00	184 x 125							84,40		
17,25	191 x 130									
17,50	191 x 130							120,23		
17,75	191 x 130									
18,00	191 x 130							94,63		
18,25	198 x 135									
18,50	198 x 135							143,33		
18,75	198 x 135									
19,00	198 x 135							112,80		
19,25	205 x 140									
19,50	205 x 140							163,12		
19,75	205 x 140									
20,00	205 x 140							128,38		
20,50	205 x 140									
21,00	205 x 140									
21,50	209 x 140									
22,00	209 x 140									
22,50	214 x 140									
23,00	214 x 140									
23,50	220 x 145									
24,00	220 x 145									
24,50	225 x 150									
25,00	225 x 150									
26,00	243 x 157									
27,00	243 x 157									
28,00	253 x 167									
29,00	253 x 167									
30,00	258 x 171									

Brocas Metal

Rosa

Ø 16,50-30mm

BROCAS DE METAL DURO Y REFRIGERACIÓN INTERIOR DIN6537K

Ref. BC84

Ref. BC83

3xD
**DIN
6537K**
MD
**TOL D1
m7**
**TOL D2
h6**

TiAIN
**HARDOX
450**
**ALTA
PRODUCCIÓN**

Broca especial para HARDOX 450

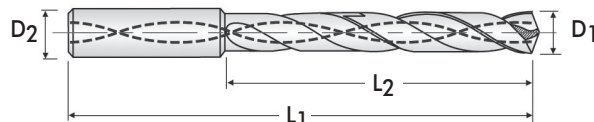

					BC84						BC83						BC84						BC83
	D1 mm	D2 mm	L1 mm	L2 mm	€		€		D1 mm	D2 mm	L1 mm	L2 mm	€		€		D1 mm	D2 mm	L1 mm	L2 mm	€		€
BC840300	3,0	6	62	20	41,19	BC830300	72,94	BC840900	9,0	10	89	47	55,58	BC830900	97,06								
BC840320	3,2	6	62	20	41,19	BC830320	72,94	BC840930	9,3	10	89	47	55,58	BC830930	97,06								
BC840350	3,5	6	62	20	41,19	BC830350	72,94	BC840950	9,5	10	89	47	55,58	BC830950	97,06								
BC840380	3,8	6	66	24	41,19	BC830380	72,94	BC840960	9,6	10	89	47	55,58	BC830960	97,06								
BC840400	4,0	6	66	24	41,19	BC830400	72,94	BC840980	9,8	10	89	47	55,58	BC830980	97,06								
BC840420	4,2	6	66	24	41,19	BC830420	72,94	BC841000	10,0	10	89	47	55,58	BC831000	97,06								
BC840450	4,5	6	66	24	41,19	BC830450	72,94	BC841020	10,2	12	102	55	83,36	BC831020	138,71								
BC840480	4,8	6	66	28	41,19	BC830480	72,94	BC841040	10,4	12	102	55	83,36	BC831040	138,71								
BC840500	5,0	6	66	28	41,19	BC830500	72,94	BC841050	10,5	12	102	55	83,36	BC831050	138,71								
BC840520	5,2	6	66	28	41,19	BC830520	72,94	BC841060	10,6	12	102	55	83,36	BC831060	138,71								
BC840550	5,5	6	66	28	41,19	BC830550	72,94	BC841080	10,8	12	102	55	83,36	BC831080	138,71								
BC840560	5,6	6	66	28	41,19	BC830560	72,94	BC841100	11,0	12	102	55	83,36	BC831100	138,71								
BC840570	5,7	6	66	28	41,19	BC830570	72,94	BC841120	11,2	12	102	55	83,36	BC831120	138,71								
BC840580	5,8	6	66	28	41,19	BC830580	72,94	BC841150	11,5	12	102	55	83,36	BC831150	138,71								
BC840590	5,9	6	66	28	41,19	BC830590	72,94	BC841180	11,8	12	102	55	83,36	BC831180	138,71								
BC840600	6,0	6	66	28	41,19	BC830600	72,94	BC841200	12,0	12	102	55	83,36	BC831200	138,71								
BC840610	6,1	8	79	34	48,23	BC830610	86,65	BC841250	12,5	14	107	60	111,15	BC831250	192,99								
BC840620	6,2	8	79	34	48,23	BC830620	86,65	BC841280	12,8	14	107	60	111,15	BC831280	192,99								
BC840630	6,3	8	79	34	48,23	BC830630	86,65	BC841300	13,0	14	107	60	111,15	BC831300	192,99								
BC840650	6,5	8	79	34	48,23	BC830650	86,65	BC841350	13,5	14	107	60	111,15	BC831350	192,99								
BC840660	6,6	8	79	34	48,23	BC830660	86,65	BC841380	13,8	14	107	60	111,15	BC831380	192,99								
BC840680	6,8	8	79	34	48,23	BC830680	86,65	BC841400	14,0	14	107	60	111,15	BC831400	192,99								
BC840690	6,9	8	79	34	48,23	BC830690	86,65	BC841450	14,5	16	115	65	139,17	BC831450	238,84								
BC840700	7,0	8	79	34	48,23	BC830700	86,65	BC841480	14,8	16	115	65	139,17	BC831480	238,84								
BC840710	7,1	8	79	41	48,23	BC830710	86,65	BC841500	15,0	16	115	65	139,17	BC831500	238,84								
BC840740	7,4	8	79	41	48,23	BC830740	86,65	BC841550	15,5	16	115	65	139,17	BC831550	238,84								
BC840750	7,5	8	79	41	48,23	BC830750	86,65	BC841600	16,0	16	115	65	139,17	BC831600	238,84								
BC840780	7,8	8	79	41	48,23	BC830780	86,65	BC841650	16,5	18	123	73	212,75	BC831650	376,59								
BC840800	8,0	8	79	41	48,23	BC830800	86,65	BC841700	17,0	18	123	73	212,75	BC831700	376,59								
BC840810	8,1	10	89	47	55,58	BC830810	97,06	BC841750	17,5	18	123	73	212,75	BC831750	376,59								
BC840820	8,2	10	89	47	55,58	BC830820	97,06	BC841800	18,0	18	123	73	212,75	BC831800	376,59								
BC840840	8,4	10	89	47	55,58	BC830840	97,06	BC841850	18,5	20	131	79	259,76	BC831850	413,84								
BC840850	8,5	10	89	47	55,58	BC830850	97,06	BC841900	19,0	20	131	79	259,76	BC831900	413,84								
BC840860	8,6	10	89	47	55,58	BC830860	97,06	BC841950	19,5	20	131	79	259,76	BC831950	413,84								
BC840870	8,7	10	89	47	55,58	BC830870	97,06	BC842000	20,0	20	131	79	259,76	BC832000	413,84								
BC840880	8,8	10	89	47	55,58	BC830880	97,06																

BROCAS DE METAL DURO Y REFRIGERACIÓN INTERIOR DIN6537L

Ref. BC97

Ref. BC89

5xD

DIN 6537L

MD

TOL D1 m7

TOL D2 h6



TiAIN

HARDOX 450

ALTA PRODUCCIÓN

Broca especial para HARDOX 450

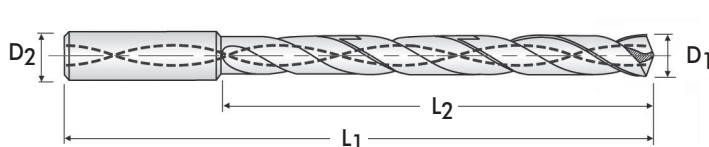

					BC97		BC89							BC97		BC89	
	D1	D2	L1	L2	€		€		D1	D2	L1	L2	€		€		
	mm	mm	mm	mm					mm	mm	mm	mm					
BC970300	3,0	6	66	28	47,83	BC890300	82,45	BC970880	8,8	10	103	61	68,07	BC890880	107,38		
BC970320	3,2	6	66	28	47,83	BC890320	82,45	BC970900	9,0	10	103	61	68,07	BC890900	107,38		
BC970350	3,5	6	66	28	47,83	BC890350	82,45	BC970930	9,3	10	103	61	68,07	BC890930	107,38		
BC970380	3,8	6	74	36	47,83	BC890380	82,45	BC970950	9,5	10	103	61	68,07	BC890950	107,38		
BC970400	4,0	6	74	36	47,83	BC890400	82,45	BC970960	9,6	10	103	61	68,07	BC890960	107,38		
BC970420	4,2	6	74	36	47,83	BC890420	82,45	BC970980	9,8	10	103	61	68,07	BC890980	107,38		
BC970450	4,5	6	74	36	47,83	BC890450	82,45	BC971000	10,0	10	103	61	68,07	BC891000	107,38		
BC970480	4,8	6	82	44	47,83	BC890480	82,45	BC971020	10,2	12	118	71	98,00	BC891020	152,89		
BC970500	5,0	6	82	44	47,83	BC890500	82,45	BC971040	10,4	12	118	71	98,00	BC891040	152,89		
BC970520	5,2	6	82	44	47,83	BC890520	82,45	BC971050	10,5	12	118	71	98,00	BC891050	152,89		
BC970550	5,5	6	82	44	47,83	BC890550	82,45	BC971060	10,6	12	118	71	98,00	BC891060	152,89		
BC970560	5,6	6	82	44	47,83	BC890560	82,45	BC971080	10,8	12	118	71	98,00	BC891080	152,89		
BC970570	5,7	6	82	44	47,83	BC890570	82,45	BC971100	11,0	12	118	71	98,00	BC891100	152,89		
BC970580	5,8	6	82	44	47,83	BC890580	82,45	BC971120	11,2	12	118	71	98,00	BC891120	152,89		
BC970590	5,9	6	82	44	47,83	BC890590	82,45	BC971150	11,5	12	118	71	98,00	BC891150	152,89		
BC970600	6,0	6	82	44	47,83	BC890600	82,45	BC971180	11,8	12	118	71	98,00	BC891180	152,89		
BC970610	6,1	8	91	53	52,38	BC890610	92,38	BC971200	12,0	12	118	71	98,00	BC891200	152,89		
BC970620	6,2	8	91	53	52,38	BC890620	92,38	BC971250	12,5	14	124	77	128,81	BC891250	207,66		
BC970630	6,3	8	91	53	52,38	BC890630	92,38	BC971300	13,0	14	124	77	128,81	BC891300	207,66		
BC970650	6,5	8	91	53	52,38	BC890650	92,38	BC971350	13,5	14	124	77	128,81	BC891350	207,66		
BC970660	6,6	8	91	53	52,38	BC890660	92,38	BC971400	14,0	14	124	77	128,81	BC891400	207,66		
BC970680	6,8	8	91	53	52,38	BC890680	92,38	BC971450	14,5	16	133	83	161,48	BC891450	260,43		
BC970690	6,9	8	91	53	52,38	BC890690	92,38	BC971500	15,0	16	133	83	161,48	BC891500	260,43		
BC970700	7,0	8	91	53	52,38	BC890700	92,38	BC971550	15,5	16	133	83	161,48	BC891550	260,43		
BC970710	7,1	8	91	53	52,38	BC890710	92,38	BC971600	16,0	16	133	83	161,48	BC891600	260,43		
BC970740	7,4	8	91	53	52,38	BC890740	92,38	BC971650	16,5	18	143	93	268,99	BC891650	411,17		
BC970750	7,5	8	91	53	52,38	BC890750	92,38	BC971700	17,0	18	143	93	268,99	BC891700	411,17		
BC970780	7,8	8	91	53	52,38	BC890780	92,38	BC971750	17,5	18	143	93	268,99	BC891750	411,17		
BC970800	8,0	8	91	53	52,38	BC890800	92,38	BC971800	18,0	18	143	93	268,99	BC891800	411,17		
BC970810	8,1	10	103	61	68,07	BC890810	107,38	BC971850	18,5	20	153	101	294,02	BC891850	449,43		
BC970840	8,4	10	103	61	68,07	BC890840	107,38	BC971900	19,0	20	153	101	294,02	BC891900	449,43		
BC970850	8,5	10	103	61	68,07	BC890850	107,38	BC971950	19,5	20	153	101	294,02	BC891950	449,43		
BC970860	8,6	10	103	61	68,07	BC890860	107,38	BC972000	20,0	20	153	101	294,02	BC892000	449,43		
BC970870	8,7	10	103	61	68,07	BC890870	107,38										

BROCA DE METAL DURO Y REFRIGERACIÓN INTERIOR DIN6537L

Brocas Metal

Rosa

8xD

Ref. BC96

**DIN
6537L**
MD
**TOL D1
m7**
**TOL D2
h6**

TiAIN
**HARDOX
450**
**ALTA
PRODUCCIÓN**

Broca especial para HARDOX 450

					BC96
	D1 mm	D2 mm	L1 mm	L2 mm	€
BC960300	3,0	6	72	34	155,97
BC960320	3,2	6	72	34	155,97
BC960350	3,5	6	72	34	155,97
BC960380	3,8	6	81	43	155,97
BC960400	4,0	6	81	43	155,97
BC960420	4,2	6	81	43	155,97
BC960450	4,5	6	81	43	155,97
BC960480	4,8	6	95	57	155,97
BC960500	5,0	6	95	57	155,97
BC960520	5,2	6	95	57	155,97
BC960550	5,5	6	95	57	155,97
BC960560	5,6	6	95	57	155,97
BC960570	5,7	6	95	57	155,97
BC960580	5,8	6	95	57	155,97
BC960590	5,9	6	95	57	155,97
BC960600	6,0	6	95	57	155,97
BC960610	6,1	8	114	76	169,90
BC960620	6,2	8	114	76	169,90
BC960630	6,3	8	114	76	169,90
BC960650	6,5	8	114	76	169,90
BC960660	6,6	8	114	76	169,90
BC960680	6,8	8	114	76	169,90
BC960690	6,9	8	114	76	169,90
BC960700	7,0	8	114	76	169,90
BC960710	7,1	8	114	76	169,90
BC960740	7,4	8	114	76	169,90
BC960750	7,5	8	114	76	169,90
BC960780	7,8	8	114	76	169,90
BC960800	8,0	8	114	76	169,90
BC960810	8,1	10	142	95	230,06
BC960840	8,4	10	142	95	230,06
BC960850	8,5	10	142	95	230,06
BC960860	8,6	10	142	95	230,06
BC960870	8,7	10	142	95	230,06
BC960880	8,8	10	142	95	230,06
BC960900	9,0	10	142	95	230,06
BC960930	9,3	10	142	95	230,06
BC960950	9,5	10	142	95	230,06
BC960960	9,6	10	142	95	230,06
BC960980	9,8	10	142	95	230,06
BC961000	10,0	10	142	95	230,06
BC961020	10,2	12	162	114	303,30
BC961040	10,4	12	162	114	303,30
BC961050	10,5	12	162	114	303,30
BC961060	10,6	12	162	114	303,30
BC961080	10,8	12	162	114	303,30
BC961100	11,0	12	162	114	303,30
BC961120	11,2	12	162	114	303,30
BC961150	11,5	12	162	114	303,30
BC961180	11,8	12	162	114	303,30
BC961200	12,0	12	162	114	303,30

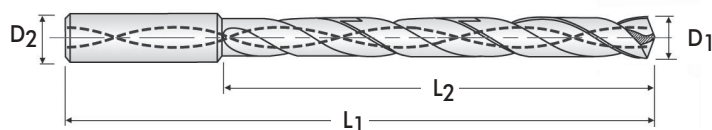
 Consulte herramientas disponibles L1 10 x Ø
 L1 15 x Ø
 L1 20 x Ø

BROCAS MICROMÉTRICAS CON MANGO REFORZADO

Ref. BC30

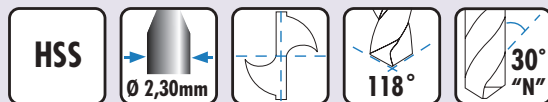

	D1	L1	L2	BC30
	mm	mm	mm	€
BC300040	0,40	43	5	2,65
BC300050	0,50	43	5	2,65
BC300060	0,60	43	7	2,65
BC300070	0,70	43	7	2,65
BC300075	0,75	43	7	2,65
BC300080	0,80	43	7	2,65
BC300090	0,90	43	7	2,65
BC300095	0,95	43	7	2,65
BC300100	1,00	43	7	2,65
BC300110	1,10	43	7	2,65
BC300120	1,20	43	10	2,65
BC300125	1,25	43	10	2,65
BC300130	1,30	43	10	2,65

	D1	L1	L2	BC30
	mm	mm	mm	€
BC300140	1,40	43	10	2,65
BC300150	1,50	43	10	2,65
BC300160	1,60	43	10	2,65
BC300170	1,70	43	10	2,65
BC300175	1,75	43	10	2,65
BC300180	1,80	43	10	2,65
BC300190	1,90	43	10	2,65
BC300200	2,00	43	10	2,65
BC300210	2,10	43	10	2,65
BC300220	2,20	43	10	2,65
BC300225	2,25	43	10	2,65
BC300235	2,35	43	10	2,65
BC300240	2,40	43	10	2,65

Ref. BC79



* Especial para circuitos impresos.



	D1	L1	L2	BC79
	mm	mm	mm	€
BC790025	0,25	38	5	54,68
BC790030	0,30	38	5	40,37
BC790035	0,35	38	5	18,96
BC790040	0,40	38	5	16,96
BC790045	0,45	38	5	17,15
BC790050	0,50	38	5	12,01
BC790055	0,55	38	5	12,01
BC790060	0,60	38	5	12,01
BC790065	0,65	38	5	10,84
BC790070	0,70	38	10	10,84
BC790075	0,75	38	10	10,84
BC790080	0,80	38	10	10,84
BC790085	0,85	38	10	10,84
BC790090	0,90	38	10	10,84
BC790095	0,95	38	10	10,84
BC790100	1,00	38	10	10,84
BC790105	1,05	38	10	10,84
BC790110	1,10	38	10	10,84
BC790115	1,15	38	10	10,84
BC790120	1,20	38	10	10,84
BC790125	1,25	38	10	10,84
BC790130	1,30	38	10	10,84
BC790135	1,35	38	10	10,84
BC790140	1,40	38	10	10,84
BC790145	1,45	38	10	10,84
BC790150	1,50	38	10	10,84
BC790155	1,55	38	10	10,84
BC790160	1,60	38	10	10,84
BC790165	1,65	38	10	13,62
BC790170	1,70	38	10	13,62

	D1	L1	L2	BC79
	mm	mm	mm	€
BC790175	1,75	38	10	13,62
BC790180	1,80	38	10	13,62
BC790185	1,85	38	10	13,62
BC790190	1,90	38	10	13,62
BC790195	1,95	38	10	13,62
BC790200	2,00	38	10	13,62
BC790205	2,05	38	10	13,62
BC790210	2,10	38	10	13,62
BC790215	2,15	38	10	13,62
BC790220	2,20	38	10	13,62
BC790225	2,25	38	10	13,62
BC790230	2,30	38	10	13,62
BC790235	2,35	38	10	13,62
BC790240	2,40	38	10	13,62
BC790245	2,45	38	10	13,62
BC790250	2,50	38	10	13,62
BC790255	2,55	38	10	13,62
BC790260	2,60	38	10	13,62
BC790265	2,65	38	10	13,62
BC790270	2,70	38	10	13,62
BC790275	2,75	38	10	13,62
BC790280	2,80	38	10	13,62
BC790285	2,85	38	10	13,62
BC790290	2,90	38	10	13,62
BC790295	2,95	38	10	13,62
BC790300	3,00	38	10	13,62
BC790305	3,05	38	10	13,62
BC790310	3,10	38	10	13,62
BC790315	3,15	38	10	13,62

BROCA DE METAL DURO PARA ACEROS TEMPLADOS Y BLINDADOS DE ALTA RESISTENCIA
**70
HRC**

Ref. BC85

MD

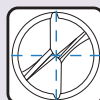
TOL D1
h7TOL D2
h6

TiAIN

HARDOX
600ALTA
PRODUCCIÓN

Broca especial para HARDOX 600

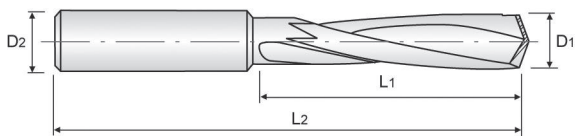

TALADRADO DE TORNILLOS Y MACHOS ROTOS

					BC85
	D1 mm	D2 mm	L1 mm	L2 mm	€
BC850300	3,0	3	46	16	39,48
BC850330	3,3	4	48	18	45,30
BC850340	3,4	4	50	20	45,30
BC850350	3,5	4	50	20	45,30
BC850400	4,0	4	52	22	46,22
BC850420	4,2	6	65	25	65,63
BC850430	4,3	6	68	28	65,63
BC850440	4,4	6	68	28	65,63
BC850450	4,5	6	68	28	65,63
BC850500	5,0	6	72	32	65,63
BC850510	5,1	6	72	32	65,63
BC850520	5,2	6	72	32	65,63
BC850550	5,5	6	75	35	65,63
BC850600	6,0	6	75	35	65,63
BC850650	6,5	8	80	40	72,83
BC850680	6,8	8	85	45	72,83
BC850690	6,9	8	85	45	72,83
BC850700	7,0	8	85	45	72,83
BC850750	7,5	8	85	45	72,83
BC850800	8,0	8	98	50	72,83
BC850850	8,5	10	98	50	111,30
BC850860	8,6	10	105	57	111,30
BC850880	8,8	10	105	57	111,30
BC850900	9,0	10	105	57	111,30
BC850950	9,5	10	105	57	111,30
BC851000	10,0	10	111	63	111,30
BC851020	10,2	12	111	63	144,15
BC851030	10,3	12	111	63	169,14
BC851050	10,5	12	111	63	169,14
BC851080	10,8	12	119	71	169,14
BC851100	11,0	12	119	71	169,14
BC851150	11,5	12	119	71	169,14
BC851200	12,0	12	119	71	169,14
BC851400	14,0	14	125	77	192,20

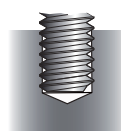
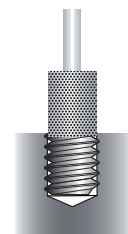
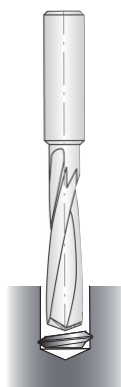

Tornillo roto

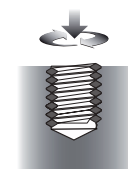
PASO 1
Limpiar la superficiePASO 2
Taladrado con la
broca BC85PASO 3
Retirar los restosPASO 4
(Opcional)
Reparar la rosca
con insertos



CONDICIONES DE CORTE

DUREZA (HRC)	50-55		55-60		60-70	
VC	14-22 m/min		10-16 m/min		8-13 m/min	
Diámetro Perforación	(R.P.M.)	AVANCE (mm/rev)	(R.P.M.)	AVANCE (mm/rev)	(R.P.M.)	AVANCE (mm/rev)
3	1900	0.04	1330	0.04	1000	0.04
4	1430	0.04	1000	0.04	750	0.04
5	1150	0.04	800	0.04	600	0.04
6	960	0.04	670	0.04	500	0.04
8	720	0.04	500	0.04	370	0.04
10	570	0.04	400	0.04	300	0.04
12	480	0.04	330	0.04	250	0.04
14	438	0.04	282	0.04	210	0.04

BROCA ANTICHISPA PARA TRABAJOS EN ATMÓSFERAS EXPLOSIVAS (ATEX)

Ref. BACH
30 HRC

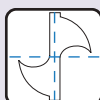
Cu-Be



118°



- * Fabricada en Cobre-Berilio, de acuerdo con el estándar Q/ZBF-312
- * Certificados y fichas de seguridad disponibles
- * Apta para trabajar en atmósferas explosivas

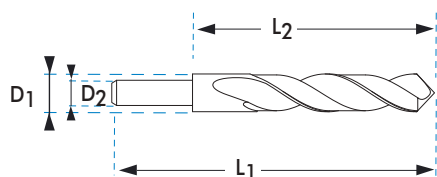

	D1 mm	D2 mm	L1 mm	L2 mm	BACH €
BACH0600	6,0	6,0	100	60	357,57
BACH0700	7,0	7,0	120	80	372,42
BACH0800	8,0	8,0	140	80	395,35
BACH0900	9,0	9,0	160	86	412,22
BACH1000	10,0	10,0	180	108	435,16
BACH1100	11,0	11,0	200	125	450,00
BACH1200	12,0	12,0	220	135	464,85
BACH1300	13,0	12,0	240	150	482,39
BACH1400	14,0	12,0	260	160	497,23
BACH1500	15,0	12,0	280	190	512,07
BACH1600	16,0	12,0	300	195	545,13
BACH1700	17,0	12,0	300	195	571,44
BACH1800	18,0	12,0	320	195	622,04
BACH1900	19,0	12,0	320	205	646,33
BACH2000	20,0	12,0	330	205	682,76

* Especiales bajo demanda

BROCA CUADRADA PARA TALADRAR BOMBILLOS

Ref. BCC06

MD

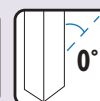
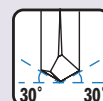
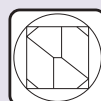

* Apta para taladrar los pitones "Anti-drilling" de cualquier cilindro.

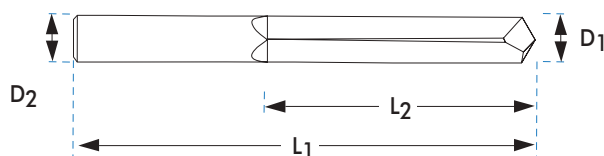

	D1 mm	D2 mm	L2 mm	L1 mm	BCC06 €
BCC06X60MD	6	6	33	60	62,38

* Para taladrar cilindros con pitones anti-drilling trabajar a 300RPM

BROCAS HELICOIDALES CON MANGO CILÍNDRICO, SERIE LARGA Y EXTRACORTA

Brocas Metal

Rosca

DIN 340



DIN 1897



		BC4	BC47	BC40	BC44	BC48	BC78										
		HSS	HSSCo 5%	HSS	HSSCo 5%	HSSCo 5%	PMD	BC3	BC31	BC37	BC35	BC33	BC77	BC43	BC17	BC38	
MATERIAL		HSS	HSSCo 5%	HSS	HSSCo 5%	HSSCo 5%	PMD	HSS	HSSCo 5%	HSS	HSSCo 5%	HSSCo 5%	PMD	MD	HSS	HSSCo 5%	
AFILADO																	
ÁNGULO PUNTA		118°	135°	118°	135°	135°	118°	135°	135°	135°	118°	135°	118°	135°	135°	135°	
HÉLICE																	
ACABADO		OX	DORADO	TiN	BRILLANTE	TiAlN	BRILLANTE	OX	DORADO	TiN	TiAlN	BRILLANTE	BRILLANTE	BRILLANTE	OX	DORADO	
APLICACIÓN																	
Ø mm	L1 x L2	€	€	€	€	€	€	L1 x L2	€	€	€	€	€	€	€	€	
0,50	32x13	5,21															
0,60	37x17	4,23															
0,70	42x21	4,23															
0,80	47x23	4,22															
0,90	51x25	4,22															
1,00	56x33	4,26						26x6	1,08	1,85	3,80		3,28		8,24		
1,10	56x33	4,14						26x6	1,35								
1,20	60x37	4,14						26x6	1,35								
1,25	65x41	4,28						30x8	0,94	2,17	4,05						
1,30	65x41	4,14						30x8	1,35								
1,40	70x45	4,14						30x9	1,35								
1,50	70x45	3,04		3,98				30x9	0,94	1,75	3,80		4,01		9,43		
1,60	76x50	4,14			8,38			34x10	1,08	2,27	4,05						
1,70	76x50	4,13			8,41			36x11	1,33								
1,75	80x53	3,42						36x11	1,08	2,17	4,05						
1,80	80x53	3,30			7,97			36x11	1,08	2,27	4,05						
1,90	80x53	3,30			8,41			38x12	1,20								
2,00	85x56	2,18	4,38	3,24	6,95	8,77	29,64	38x12	0,93	1,75	3,44	4,60	3,52	16,72	7,79	1,89	
2,10	85x56	3,30			7,16			38x12	1,08	2,29	4,05				8,90		
2,20	90x59	3,30			7,65			40x13	1,08	2,29	4,05				8,90		
2,25	90x59	2,66						40x13	0,93	2,26	4,05						
2,30	90x59	3,18			7,40			40x13	1,08	2,29	4,05				8,90		
2,40	95x62	3,18			9,44			43x14	1,08	2,29	4,05				8,90		
2,50	95x62	2,41	4,36	3,42	6,96	8,77	29,35	43x14	0,84	1,58	3,31	4,31	3,17	16,72	8,64	1,87	
2,60	95x62	3,19			8,65			43x14	1,02	1,84	3,60				8,90		
2,70	100x66	3,19			7,79			46x16	1,02	1,85	3,60				11,69		

**DIN
340**

**DIN
1897**

	DIN 340						DIN 1897										
	BC4	BC47	BC40	BC44	BC48	BC78	BC3	BC31	BC37	BC35	BC33	BC77	BC43	BC17	BC38		
MATERIAL	HSS	HSSCo 5%	HSS	HSSCo 5%	HSSCo 5%	PMD	HSS	HSSCo 5%	HSS	HSSCo 5%	HSSCo 5%	PMD	MD	HSS	HSSCo 5%		
AFILADO																	
ÁNGULO PUNTA	118°	135°	118°	135°	135°	118°	135°	135°	135°	118°	135°	118°	135°	135°	135°		
HÉLICE																	
ACABADO	OX	DORADO	TiN	BRILLANTE	TiAlN	BRILLANTE	OX	DORADO	TiN	TiAlN	BRILLANTE	BRILLANTE	BRILLANTE	OX	DORADO		
APLICACIÓN																	
Ø mm	L1 x L2	€	€	€	€	€	L1 x L2	€	€	€	€	€	€	€	€		
2,75	100x66	3,28					46x16	0,88	1,91	3,60							
2,80	100x66	3,19			8,65		46x16	1,03	1,85	3,60			11,69				
2,90	100x66	3,19			8,64		46x16	1,03	1,85	3,60			11,69				
3,00	100x66	2,22	4,36	3,28	6,98	8,76	26,37	46x16	0,88	1,58	3,31	4,19	2,95	15,18	10,93	1,64	
3,10	106x69	2,49	4,98	3,83	7,93	10,28		49x18	0,95	1,66	4,02		3,29		11,88	1,65	
3,20	106x69	2,49			7,95	10,22		49x18	0,95	1,66	4,02		3,29		11,88	1,65	
3,25	106x69	2,49	4,98	3,83				49x18	0,95	1,66	4,01			19,98		1,65	2,42
3,30	106x69	2,49			7,97	10,19		49x18	0,96	1,66	4,02	5,18	3,29		11,88	1,64	
3,40	112x73	3,20			10,09			52x20	1,08	2,05	4,38		3,19		12,78	1,84	
3,50	112x73	2,34	5,14	3,66	8,22	10,51	25,25	52x20	0,95	1,66	4,01	5,15	3,48	15,18	11,92	1,83	2,92
3,60	112x73	3,20			9,58			52x20	1,20	2,05	4,38		4,01		14,05		
3,70	112x73	3,20			9,93			52x20	1,20	2,05	4,38	5,76	4,01		14,05		
3,75	112x73	3,31	5,86	4,64				52x20	1,06	2,11	4,38						2,09
3,80	119x78	3,97			11,93			55x22	1,20	2,05	4,38		4,02		15,12		2,02
3,90	119x78	3,97			10,54			55x22	1,20	2,05	4,38		4,02		15,12		
4,00	119x78	2,54	5,31	3,91	8,43	10,78	26,16	55x22	1,06	1,87	4,14	5,37	3,85	15,15	14,13	1,86	2,99
4,10	119x78	3,32			9,36	11,72		55x22	1,26	2,23	4,47		4,19		15,88		2,02
4,20	119x78	3,32			9,37	11,68		55x22	1,26	2,23	4,47	5,88	4,24	17,76	15,88		2,02
4,25	119x78	3,32	5,85	4,64				55x22	1,26	2,23	4,43						2,02
4,30	126x82	4,30			10,43	12,65		58x24	1,44	2,55	4,79		4,50		16,84		
4,40	126x82	4,30			10,86			58x24	1,44	2,55	4,79		4,65		16,84		
4,50	126x82	3,05	6,58	4,39	10,34	12,74	26,74	58x24	1,26	2,23	4,43	5,97	4,32	16,59	16,35		2,09
4,60	126x82	4,31			13,97			58x24	1,62	2,67	4,90		5,19		16,84		
4,70	126x82	4,31			10,37			58x24	1,62	2,67	4,90		4,99		18,04		
4,75	126x82	4,47	6,61	5,80				58x24	1,39	2,48	4,66						3,37
4,80	132x87	4,96			10,86			62x26	1,62	2,67	4,90		5,07		18,04		
4,90	132x87	4,96			15,06			62x26	1,62	2,67	4,90		5,19		18,04		
5,00	132x87	3,25	6,58	4,58	10,50	12,74	26,99	62x26	1,39	2,47	4,66	6,29	4,72	17,94	16,81	2,40	3,82
5,10	132x87	4,96			12,19	14,46		62x26	1,79	3,05	5,21		5,43		18,04		3,24
5,20	132x87	4,96			12,22			62x26	1,77	3,01	5,21		5,59		23,37		3,24
5,25	132x87	5,17	7,74	6,47				62x26	1,54	2,75	4,90						3,37
5,30	132x87	5,39			12,69	14,97		62x26	1,79	3,01	5,21		5,73		23,37		
5,40	139x91	5,39			17,69			66x28	1,79	3,01	5,21		5,90		23,37		
5,50	139x91	4,29	8,96	5,60	14,17	16,45	29,28	66x28	1,54	2,75	4,90	7,32	5,60	21,44	22,68		2,88
5,60	139x91	5,40			14,69			66x28	2,05	3,21	5,40		6,20		24,83		
5,70	139x91	5,40			11,56			66x28	2,07	3,21	5,40		6,40		24,83		
5,75	139x91	5,61	9,01	6,91				66x28	1,78	3,33	5,40						4,00
5,80	139x91	5,93			14,83			66x28	2,05	3,21	5,40		6,21		24,83		
5,90	139x91	5,93			15,25			66x28	2,07	3,21	5,40		6,19		24,83		
6,00	139x91	3,96	8,96	5,25	14,23	16,58	29,25	66x28	1,77	3,13	5,21	7,68	5,98	23,44	24,57		3,25
6,10	148x97	5,93			19,91			70x31	2,42	4,05	9,77		7,30		30,91		
6,20	148x97	5,93			18,59			70x31	2,42	4,05	9,77		7,19		30,91		
6,25	148x97	6,17						70x31	2,09	4,18	9,77						
6,30	148x97	6,00						70x31	2,42	4,05	9,77		7,46		30,91		
6,40	148x97	6,00						70x31	2,42	4,02	9,77		7,47		30,91		
6,50	148x97	5,10	10,29	8,60	16,43	22,46	31,49	70x31	2,08	3,73	9,40	11,71	7,20	24,51	29,73		
6,60	148x97	6,00						74x34	2,80	5,05	10,63		8,40		36,37		
6,70	148x97	6,00			15,43			74x34	2,80	5,05	10,63		8,40		36,37		
6,75	156x102	6,24	11,97	9,70				74x34	2,45	5,21	10,63						
6,80	156x102	6,22			19,08	25,23		74x34	2,43	5,19	10,63	14,45	8,25	30,91	36,37		
6,90	156x102	6,37						74x34	2,67						36,37		

BROCAS HELICOIDALES CON MANGO CILÍNDRICO, SERIE LARGA Y EXTRACORTA

Brocas Metal

Roso

**DIN
340**

**DIN
1897**

		BC4	BC47	BC40	BC44	BC48	BC78										
		BC3	BC31	BC37	BC35	BC33	BC77	BC43	BC17	BC38							
MATERIAL		HSS	HSSCo 5%	HSS	HSSCo 5%	HSSCo 5%	PMD		HSS	HSSCo 5%	HSS	HSSCo 5%	HSSCo 5%	PMD	MD	HSS	HSSCo 5%
AFILADO																	
ÁNGULO PUNTA		118°	135°	118°	135°	135°	118°	135°	135°	135°	118°	135°	118°	135°	135°	135°	135°
HÉLICE		30° "N"	30° "N"	30° "N"	38° "S"	38° "S"	30° "N"	30° "N"	30° "N"	30° "N"	30° "N"	30° "N"	30° "N"	30° "N"	35° "N"	30° "N"	30° "N"
ACABADO		OX	DORADO	TiN	BRILLANTE	TiAlN	BRILLANTE	OX	DORADO	TiN	TiAlN	BRILLANTE	BRILLANTE	BRILLANTE	BRILLANTE	OX	DORADO
APLICACIÓN		70 Kg/mm²	120 Kg/mm²	PRODUCCIÓN	INOX	INOX	FUNDICIÓN	70 Kg/mm²	120 Kg/mm²	PRODUCCIÓN	INOX Plus	INOX	FUNDICIÓN	ALTA PRODUCCIÓN	70 Kg/mm²	120 Kg/mm²	
Ø mm	L1 x L2	€	€	€	€	€	€	L1 x L2	€	€	€	€	€	€	€	€	€
7,00	156x102	5,93	12,01	9,49	19,15	25,62	31,49	74x34	2,43	4,28	9,86	12,59	8,23	26,92	34,94	4,24	
7,10	156x102	6,37						74x34							44,31		
7,20	156x102	6,37			23,27			74x34	3,16						43,46		
7,25	156x102	6,64						74x34	2,75	5,58	10,90						
7,30	156x102	6,51						74x34							44,31		
7,40	156x102	6,51						74x34							44,31		
7,50	156x102	6,32	12,76	9,83	20,42	26,78	35,88	74x34	2,75	5,21	10,90	14,90	9,83	28,29	40,35		
7,60	165x109	6,51						79x37							49,05		
7,70	165x109	6,51						79x37							50,00		
7,75	165x109	6,76						79x37	3,03	6,03	10,99						
7,80	165x109	7,28			28,07			79x37	3,47	6,23	10,99	22,58	10,69		49,05		
7,90	165x109	7,28						79x37							49,05		
8,00	165x109	6,98	14,27	10,59	22,67	28,85	35,88	79x37	3,00	5,39	10,78	14,73	10,29	30,18	45,97	5,25	
8,10	165x109	7,28						79x37							59,81		
8,20	165x109	7,28			25,50			79x37							60,98		
8,25	165x109	7,57						79x37	3,61	7,11	13,56						
8,30	165x109	11,11						79x37							60,98		
8,40	165x109	11,20						79x37							60,98		
8,50	165x109	7,84	15,83	11,98	25,09	32,75	45,40	79x37	3,61	6,38	13,01	17,45	11,97	33,12	58,94		
8,60	175x115	11,20						84x40							64,90		
8,70	175x115	11,20						84x40							66,16		
8,75	175x115	11,64						84x40	3,94	7,72	14,08						
8,80	175x115	11,44			27,24			84x40							64,90		
8,90	175x115	11,44						84x40							66,16		
9,00	175x115	8,50	17,15	12,60	27,54	34,91	39,68	84x40	3,91	7,00	13,49	18,51	13,01	35,29	57,29		

DIN
340

DIN
1897

		BC4	BC47	BC40	BC44	BC48	BC78										BC3	BC31	BC37	BC35	BC33	BC77	BC43	BC17	BC38
MATERIAL		HSS	HSSCo 5%	HSS	HSSCo 5%	HSSCo 5%	PMD										HSS	HSSCo 5%	HSS	HSSCo 5%	HSSCo 5%	PMD	MD	HSS	HSSCo 5%
AFILADO																									
ÁNGULO PUNTA		118°	135°	118°	135°	135°	118°										135°	135°	135°	118°	135°	118°	135°	135°	135°
HÉLICE		30° "N"	30° "N"	30° "N"	38° "S"	38° "S"	30° "N"										30° "N"	30° "N"	30° "N"	38° "S"	38° "S"	30° "N"	35° "N"	30° "N"	30° "N"
ACABADO		OX	DORADO	TiN	BRILLANTE	TiAlN	BRILLANTE										OX	DORADO	TiN	TiAlN	BRILLANTE	BRILLANTE	BRILLANTE	OX	DORADO
APLICACIÓN				PRODUCCIÓN	INOX	INOX	FUNDICIÓN												PRODUCCIÓN	INOX Plus	INOX	FUNDICIÓN	ALTA PRODUCCIÓN		
Ø mm L1 x L2	€	€	€	€	€	€	€	L1 x L2	€	€	€	€	€	€	€	€	€	€	€	€	€	€			
9,10 175x115	11,45							84x40													70,99				
9,20 175x115	11,45				34,66			84x40														72,37			
9,25 175x115	11,90							84x40	4,43	8,73	14,99														
9,30 175x115	12,30							84x40														72,37			
9,40 175x115	12,30							84x40														72,37			
9,50 175x115	8,62	17,35	12,68	27,73	35,28	42,24	84x40	4,43	7,92	14,23	20,14	14,52	37,99	66,21											
9,60 184x121	12,31						89x43															74,70			
9,70 184x121	12,30						89x43															74,70			
9,75 184x121	12,80						89x43	4,94	9,66	16,28															
9,80 184x121	12,32				46,74		89x43															74,70			
9,90 184x121	12,30						89x43															73,28			
10,00 184x121	9,28	18,78	13,51	29,86	37,52	41,94	89x43	4,94	8,76	14,98	21,84	16,12	41,06	65,34											
10,10 184x121	13,53																								
10,20 184x121	12,61						89x43	5,58	9,78	25,39	31,04	16,98		81,25											
10,25 184x121	11,67	27,59	20,39				89x43	6,21																	
10,30 184x121	17,92																								
10,40 184x121	15,55																								
10,50 184x121	12,58	25,43	21,32	39,93	55,29	56,90	89x43	5,57	9,79	25,00		18,15	44,73	80,49											
10,60 195x128	17,59																								
10,70 195x128	17,59																								
10,75 195x128	12,80						95x47	6,86																	
10,80 195x128	16,03																								
10,90 195x128	17,59																								
11,00 195x128	13,97	28,26	22,54	44,06	60,38	56,90	95x47	6,21	10,94	25,77	34,18	19,99	47,97	85,93											
11,10 195x128	17,30																								
11,20 195x128	16,81																								
11,25 195x128	16,64																								
11,30 195x128	20,07																								
11,40 195x128	20,07																								
11,50 195x128	14,26	29,68	23,03	47,44	61,80	70,56	95x47	6,89	12,92	26,74		21,26	51,74	100,62											
11,60 195x128	20,07																								
11,70 195x128	20,07																								
11,75 195x128	18,72																								
11,80 195x128	18,72																								
11,90 195x128	18,72																								
12,00 205x134	15,93	32,12	24,68	51,46	65,98	65,63	102x51	7,26	13,82	27,31	40,82	23,90	56,30	100,62											
12,10 205x134	19,27																								
12,20 205x134	18,02																								
12,25 205x134	18,06																								
12,30 205x134	21,29																								
12,40 205x134	23,83																								
12,50 205x134	16,81	38,58	27,81	50,76	80,70	71,28	102x51	8,16	16,82	33,33		28,19	59,63	131,04											
12,60 205x134	23,83																								
12,70 205x134	23,83						102x51	8,60	19,23	36,97															
12,75 205x134	22,12																								
12,80 205x134	23,83																								
12,90 205x134	23,72																								
13,00 205x134	19,04	39,67	29,97	63,18	82,01	71,28	102x51	8,93	17,15	34,92	50,92	29,46	64,40	131,04											
13,25 214x140	22,12																								
13,50 214x140	21,26				77,33		107x54	11,34	20,12	38,02		33,86													
13,75 214x140	22,20																								

BROCAS HELICOIDALES CON MANGO CILÍNDRICO, SERIE LARGA Y EXTRACORTA

Brocas Metal

Rosca

**DIN
340**

**DIN
1897**

	BC4	BC47	BC40	BC44	BC48	BC78		BC3	BC31	BC37	BC35	BC33	BC77	BC43	BC17	BC38
MATERIAL	HSS	HSSCo 5%	HSS	HSSCo 5%	HSSCo 5%	PMD		HSS	HSSCo 5%	HSS	HSSCo 5%	HSSCo 5%	PMD	MD	HSS	HSSCo 5%
AFILADO																
ÁNGULO PUNTA	118°	135°	118°	135°	135°	118°		135°	135°	135°	118°	135°	118°	135°	135°	135°
HÉLICE	30° "N"	30° "N"	30° "N"	38° "S"	38° "S"	30° "N"		30° "N"	30° "N"	30° "N"	38° "N"	38° "S"	30° "N"	35° "N"	30° "N"	30° "N"
ACABADO	OX	DORADO	TiN	BRILLANTE	TiAlN	BRILLANTE		OX	DORADO	TiN	TiAlN	BRILLANTE	BRILLANTE	BRILLANTE	OX	DORADO
APLICACIÓN																
Ø mm	L1 x L2	€	€	€	€	€	L1 x L2	€	€	€	€	€	€	€	€	€
14,00	214x140	22,95			106,92		107x54	12,19	21,65	39,30			36,84	75,85	154,31	
14,25	220x144	41,37														
14,50	220x144	26,85					111x56	14,03	30,04	46,33			46,61		169,47	
14,75	220x144	41,37														
15,00	220x144	26,00					89,51	111x56	16,05	30,50	46,70		44,13	93,73	170,65	
15,25	227x149	46,67														
15,50	227x149	38,57						115x58	19,33	35,27	50,68		51,00		204,00	
15,75	227x149	46,68														
16,00	227x149	30,26					110,75	115x58	19,33	36,58	51,79		51,91	108,72	206,05	
16,25	235x154	51,51														
16,50	235x154	35,80						119x60	22,73	41,83	59,45					
16,75	235x154	51,51														
17,00	235x154	35,96					141,14	119x60	22,73	41,83	59,45					
17,25	241x158	59,22														
17,50	241x158	53,13						123x62	25,32	46,33	63,20					
17,75	241x158	69,19														
18,00	241x158	37,48					147,67	123x62	25,32	50,48	66,68				310,24	
18,25	247x162	72,35														
18,50	247x162	58,04						127x64	28,21	55,74	75,05					
18,75	247x162	100,74														
19,00	247x162	47,00						127x64	28,21	55,74	75,05				435,00	
19,25	254x166	104,79														
19,50	254x166	90,38						131x66	33,82	61,82	80,13					
19,75	254x166	102,06														
20,00	254x166	52,73					204,86	131x66	33,82	66,24	84,86				435,00	

BROCAS HELICOIDALES CON MANGO CILÍNDRICO SERIE EXTRALARGA



Ref. BC8



Ref. BC88

		BC8	BC88			BC8	BC88			BC8	BC88
MATERIAL		HSS	HSSCo 5%	Ø mm	L1 x L2	€	€	Ø mm	L1 x L2	€	€
AFILADO				5,50	205x140	18,58	21,59	9,25	320x220		93,36
ÁNGULO PUNTA				5,50	260x180	26,47	32,67	9,25	410x280		116,75
HÉLICE				5,50	330x225	30,69	40,16	9,50	250x175	44,32	62,62
ACABADO				5,75	205x140	22,43	26,74	9,50	320x220	61,26	81,29
APLICACIÓN				5,75	260x180	31,02	36,97	9,50	410x280	82,35	108,05
				5,75	330x225	37,98	44,87	9,75	265x185		74,70
				6,00	205x140	18,55	21,58	9,75	340x235		97,28
				6,00	260x180	26,62	32,67	9,75	430x295		125,38
				6,00	330x225	30,57	40,29	10,00	265x185	44,10	56,76
				6,25	215x150		31,34	10,00	340x235	57,36	74,73
				6,25	275x190		38,69	10,00	430x295	79,68	105,34
				6,25	350x235		49,94	10,25	265x185		110,69
				6,50	215x150	22,00	26,75	10,25	340x235		120,00
				6,50	275x190	28,47	36,05	10,25	430x295		127,61
				6,50	350x235	35,47	46,01	10,50	265x185	81,26	95,96
				6,75	225x155		34,04	10,50	340x235	88,06	104,02
				6,75	290x200		44,68	10,50	430x295	93,66	110,62
				6,75	370x250		63,35	10,75	280x195		110,69
				7,00	225x155	23,40	33,19	10,75	365x250		120,00
				7,00	290x200	32,56	40,29	10,75	455x310		127,61
				7,00	370x250	44,00	59,34	11,00	280x195	55,64	71,95
				7,25	225x155		43,36	11,00	365x250	79,07	93,40
				7,25	290x200		53,46	11,00	455x310	92,57	109,31
				7,25	370x250		71,41	11,25	280x195		103,10
				7,50	225x155	26,31	36,62	11,25	365x250		138,41
				7,50	290x200	35,09	48,00	11,25	455x310		142,97
				7,50	370x250	51,09	67,39	11,50	280x195	75,66	89,38
				7,75	240x165		44,68	11,50	365x250	101,58	119,99
				7,75	305x210		53,46	11,50	455x310	104,96	123,95
				7,75	390x265		78,99	11,75	280x195		103,10
				8,00	240x165	29,09	37,37	11,75	365x250		138,41
				8,00	305x210	40,34	46,75	11,75	455x310		142,97
				8,00	390x265	52,81	69,22	12,00	295x205	73,20	81,29
				8,25	240x165		58,59	12,00	375x260	89,21	105,34
				8,25	305x210		77,78	12,00	480x330	108,55	128,20
				8,25	390x265		94,49	12,25	295x205		120,00
				8,50	240x165	39,55	50,70	12,25	375x260		134,38
				8,50	305x210	54,25	70,70	12,25	480x330		163,11
				8,50	390x265	73,72	86,59	12,50	295x205	88,06	104,02
				8,75	240x165		62,61	12,50	375x260	98,62	116,48
				8,75	320x220		77,78	12,50	480x330	119,71	141,37
				8,75	410x280		99,47	12,75	295x205		120,00
				9,00	250x175	37,80	54,10	12,75	375x260		134,38
				9,00	320x220	49,65	67,98	12,75	480x330		163,11
				9,00	410x280	73,29	91,93	13,00	295x205	88,06	104,02
				9,25	250x175		73,21	13,00	375x260	101,60	119,99
								13,00	480x330	120,84	142,71

* Longitudes especiales bajo demanda.

BROCA HELICOIDAL PARA AERONÁUTICA, SERIE EXTRA LARGA

Brocas Metal

Rosa

Ref. BC08

HSS

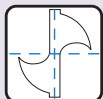
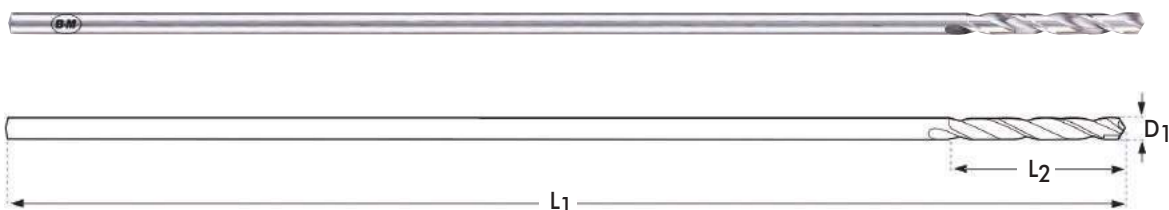
AIRCRAFT

150 mm

				BC08
	D ₁ mm	L ₁ mm	L ₂ mm	€
BC080225150	2,25	150	25	11,64
BC080250150	2,50	150	25	11,23
BC080320150	3,20	150	26	11,21
BC080325150	3,25	150	36	11,05
BC080400150	4,00	150	43	11,43

300 mm

				BC08
	D ₁ mm	L ₁ mm	L ₂ mm	€
BC080225300	2,25	300	25	12,36
BC080250300	2,50	300	25	11,68
BC080320300	3,20	300	26	11,71
BC080325300	3,25	300	36	11,67
BC080400300	4,00	300	43	13,06

* Otras dimensiones disponibles bajo demanda

BROCA DE METAL DURO HELICOIDAL PARA AERONÁUTICA, SERIE EXTRALARGA

Ref. BC08PMD

PMD

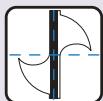
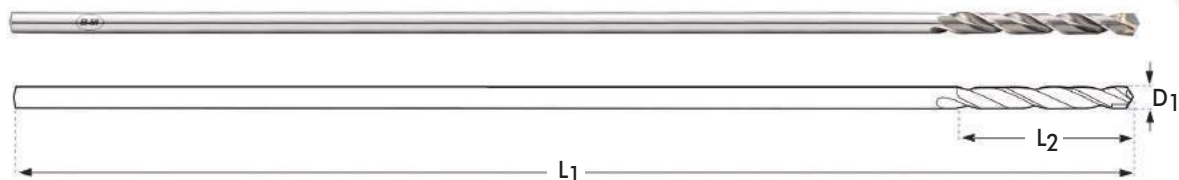
**AIRCRAFT
MD**

* Disponibilidad serie Aircraft MD. Fabricación de medidas especiales bajo demanda.

BROCAS DE CENTRAR

Ref. BC10
Ref. BC10Co
Ref. BC65
Ref. BC10MD



Ref. BC64
Ref. BC68

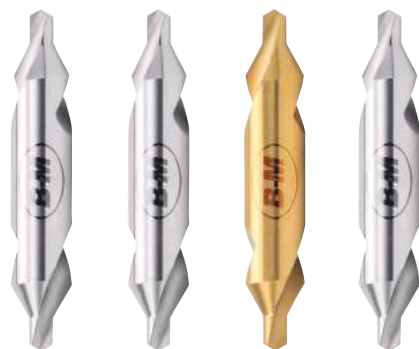
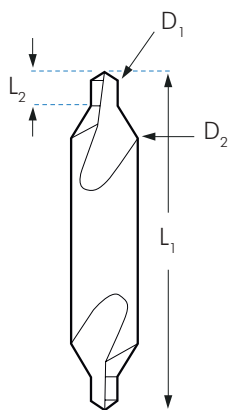

SERIE LARGA



D1 x D2 mm	L1 x L2 mm	BC10	BC10Co	BC65	BC10MD
		HSS €	HSSCo 5% €	TiN €	MD €
1,00 x 3,15	31 x 1	4,93	7,37	9,79	52,68
1,25 x 3,15	33 x 1	4,93	7,37	9,79	52,68
1,25 x 4,00	35 x 1	5,24		10,46	
1,60 x 4,00	37 x 2	4,93	7,37	10,17	56,26
1,60 x 5,00	40 x 2	5,21		11,04	
2,00 x 5,00	42 x 2	5,30	7,93	11,13	64,11
2,00 x 6,30	45 x 2	5,30	7,93	11,13	64,11
2,50 x 6,30	47 x 3	5,89	8,81	12,13	73,06
2,50 x 8,00	50 x 3	6,50		12,72	
3,15 x 8,00	52 x 4	6,48	9,69	12,78	81,97
3,15 x 10,00	56 x 4	7,66			
4,00 x 10,00	59 x 5	8,99	12,84	17,16	100,13
4,00 x 12,50	63 x 5	10,47			
5,00 x 12,50	66 x 6	15,77	21,16		167,23
5,00 x 16,00	71 x 6	24,98			
6,30 x 16,00	74 x 8	21,57	30,29		259,51
6,30 x 20,00	80 x 8	38,02			
8,00 x 20,00	81 x 27	64,30	82,87		
10,00 x 25,00	100 x 31	64,62	91,20		
12,50 x 31,50	125 x 33	153,70	199,76		

D1 x D2 mm	L1 x L2 mm	BC64	BC68
		HSS €	TiN €
1,00 x 4,00	60 x 1	16,89	25,61
1,00 x 4,00	120 x 1	34,11	65,14
1,50 x 5,00	60 x 2	17,22	25,94
1,50 x 5,00	120 x 2	34,77	57,64
2,00 x 6,00	80 x 2	17,94	28,17
2,00 x 6,00	120 x 2	27,18	56,96
2,50 x 8,00	80 x 3	21,83	36,63
2,50 x 8,00	120 x 3	33,06	67,52
3,00 x 8,00	80 x 4	21,83	36,63
3,00 x 8,00	120 x 4	33,06	67,52
3,00 x 10,00	100 x 4	28,19	46,07
3,00 x 10,00	120 x 4	34,15	76,42
4,00 x 10,00	100 x 5	28,22	46,07
4,00 x 10,00	120 x 5	34,20	76,42
4,00 x 12,00	100 x 5	38,01	68,80
4,00 x 12,00	120 x 5	46,05	97,30
5,00 x 14,00	120 x 6	64,47	117,27

Ref. BC62

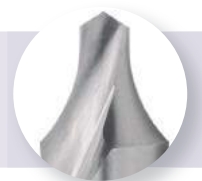

D1 x D2 mm	L1 x L2 mm	BC62 €
1,00 x 3,15	31 x 3	5,41
1,25 x 3,15	31 x 3	5,41
1,25 x 4,00	35 x 3	5,38
1,60 x 4,00	37 x 4	5,41
1,60 x 5,00	40 x 4	6,07
2,00 x 5,00	42 x 5	5,86
2,00 x 6,30	45 x 6	6,79
2,50 x 6,30	47 x 6	6,51
2,50 x 8,00	50 x 7	7,15
3,15 x 8,00	52 x 8	7,15

D1 x D2 mm	L1 x L2 mm	BC62 €
3,15 x 10,00	56 x 9	9,32
4,00 x 10,00	56 x 10	9,32
4,00 x 12,50	63 x 11	15,53
5,00 x 12,50	66 x 13	15,57
5,00 x 16,00	71 x 15	22,10
6,30 x 16,00	74 x 17	22,37
6,30 x 20,00	80 x 19	39,66
8,00 x 20,00	80 x 21	42,50
10,00 x 25,00	100 x 31	70,41
12,50 x 31,50	125 x 33	162,94

BROCA DE CENTRAR

Ref. BC63

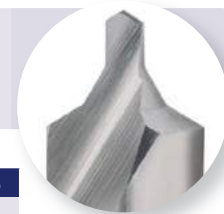
DIN
333B
HSS

		BC63
Ø mm	L1 x L2 mm	€
1,00 x 4,00	37,50 x 1,60	9,03
1,25 x 5,00	42,00 x 1,90	9,03
1,60 x 6,30	47,00 x 2,40	9,03
2,00 x 8,00	52,00 x 2,90	9,47
2,50 x 10,00	59,00 x 3,60	10,95
3,15 x 11,20	63,00 x 4,40	12,66

		BC63
Ø mm	L1 x L2 mm	€
4,00 x 14,00	70,00 x 5,60	19,47
5,00 x 18,00	78,00 x 6,90	26,91
6,30 x 20,00	83,00 x 8,60	39,26
8,00 x 25,00	100,00 x 26,00	86,71
10,00 x 31,50	125,00 x 30,00	171,83

BROCAS DE PUNTEAR

 Ref. BC75
 Ref. BC76

DIN
1412A
D₂
TOL
h6

 Ref. BC92
 Ref. BC93

DIN
1412A
D₂
TOL
h6
D₂
DIN
6535HB

Utilizadas para el centrado previo de los taladros realizados con broca.

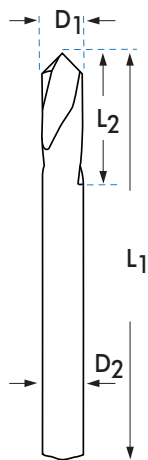

			BC75	BC76
HSSCo 5%	TiAIN		90°	120°
D1 mm	L1 x L2 mm	D2 mm	€	€
3	50 x 10	3	18,02	18,02
4	52 x 12	4	18,02	18,02
5	60 x 15	5	20,32	20,32
6	66 x 20	6	20,32	20,32
8	79 x 25	8	22,95	22,95
10	89 x 25	10	22,84	22,84
12	102 x 30	12	31,65	31,65
16	115 x 35	16	43,54	43,54
20	131 x 40	20	85,68	85,68

			BC92	BC93
MD			90°	120°
D1 mm	L1 x L2 mm	D2 mm	€	€
1,0	26 x 6	1,0	23,44	
1,5	32 x 9	1,5	23,78	
2,0	38 x 12	2,0	24,03	
3,0	45 x 12	3,0	24,37	24,37
4,0	50 x 15	4,0	24,62	24,62
5,0	50 x 18	5,0	29,33	29,33
6,0	50 x 13	6,0	38,04	38,04
8,0	60 x 23	8,0	53,55	53,55
10,0	70 x 24	10,0	75,92	75,92
12,0	70 x 24	12,0	98,02	98,02
14,0	70 x 27	14,0	147,61	147,61
16,0	75 x 29	16,0	180,38	180,38
18,0	100 x 33	18,0	268,81	268,81
20,0	100 x 35	20,0	319,84	319,84

BROCAS PARA QUITAR PUNTOS DE SOLDADURA

**BROCA CORTA
PARA MÁQUINAS NEUMÁTICAS**



**BROCA LARGA
PARA MÁQUINAS ELECTROPORTÁTILES**



			BC70	BC71	BC70MD
			HSSCo 5%	HSSCo 5% TiN	MD TiAlN
D1 mm	D2 mm	L1 x L2 mm	€	€	€
6,5	6,5	40 x 18	21,47	29,10	67,45
8,0	8,0	40 x 18	17,59	29,10	73,62
6,5	8,0	44 x 18	22,38	33,32	67,45
8,0	8,0	44 x 18	19,62	33,32	73,62

		BC60	BC69
		HSSCo 5%	HSSCo 5% TiN
Ø mm	L1 x L2 mm	€	€
6,0	66 x 26	10,61	18,62
7,0	74 x 34	15,22	24,23
8,0	79 x 36	14,07	26,25
10,0	89 x 44	17,89	27,74

BROCA ESPECIAL BC70MD METAL DURO + TiAlN

- Broca especial para **soldaduras al Boro**.
- Usar con taladros eléctricos, no neumáticos.
- 1200 RPM.
- Esfuerzos de empuje altos.
- Siempre con "CUT-MAGIC".

**CONJUNTO CORTADOR:
HUSILLO, CORONA Y PUNZÓN**

**CORONA CORTADORA:
DE 9 mm**

PUNZÓN GUÍA



EBC70-1

20,22 €



EBC70-2

14,62 €



EBC70-3

0,89 €



EBC70

Composición:

- 1 Conjunto Cortador Ref. EBC70-1
- 5 Coronas Cortadoras de 9 mm Ref. EBC70-2
- 2 Punzones guía Ref. EBC70-3
- 1 Broca Ref. BC60 Ø 8 mm

91,68 €

BROCA DE CORTE RÁPIDO

PARA PUNTOS DE SOLDADURA CON PUNZÓN GUÍA

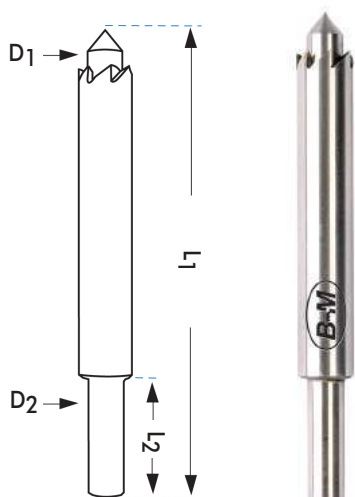

				BC72
D1	D2	L1	L2	HSSCo 5%
mm	mm	mm	mm	€
9,00	6,00	80	20	33,50

BROCA SIERRA LIMA-RASPA

PARA TALADRAR Y CONTORNEAR EN MADERA, CHAPA METÁLICA Y PLÁSTICO



* Broca especial para carroceros.

		BC80	BC81
Ø	L1 x L2	HSS	TiN
mm	mm	€	€
6,00	90 x 60	14,81	23,24
8,00	90 x 60	19,05	29,75

BROCA FRESA DE METAL DURO

Ref. BC91

MD

Utilizadas para Taladrar, Puntear, Fresar y Avellanar.

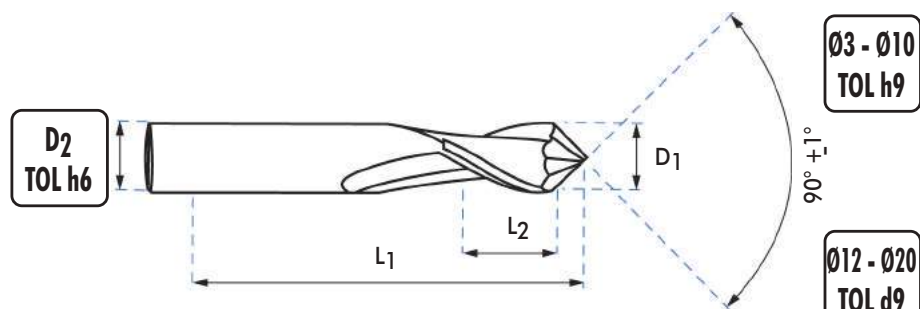

			BC91
D1	D2	L1 x L2	€
mm	mm	mm	
3	3	38 x 12	72,64
4	4	50 x 14	75,35
5	5	50 x 16	86,12
6	6	63 x 12	96,87
8	8	63 x 19	134,54
10	10	70 x 22	169,54
12	12	75 x 25	169,54
14	14	88 x 30	202,24
16	16	88 x 32	242,17
18	18	100 x 36	323,32
20	20	100 x 38	427,84

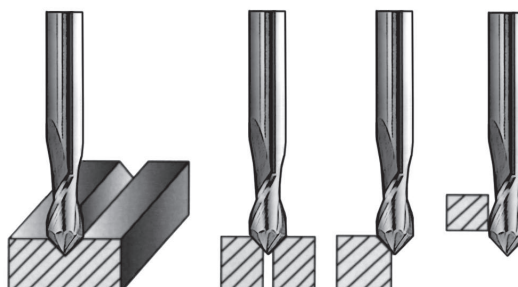

FLUOBROCAS PARA ROSCADO DE PAREDES FINAS

Con collar SIMPLE

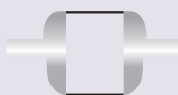

Ref. FLUOB

Con collar CORTADOR



Ref. FLUOBP

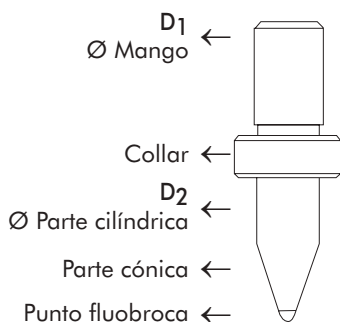

					FLUOB	FLUOBP	
	D1 mm	D2 mm	R.P.M.		€		€
M3x0,50	6	2,7	3000	FLUOBM03	110,82	FLUOBPM03	155,15
M4x0,70	6	3,7	2600	FLUOBM04	114,85	FLUOBPM04	160,79
M5x0,80	6	4,5	2500	FLUOBM05	119,95	FLUOBPM05	167,94
M6x1,00	6	5,3	2400	FLUOBM06	127,86	FLUOBPM06	179,00
M8x1,25	8	7,3	2200	FLUOBM08	157,75	FLUOBPM08	220,86
M10x1,50	10	9,2	2000	FLUOBM10	178,77	FLUOBPM10	250,29
M12x1,75	12	10,9	1800	FLUOBM12	188,13	FLUOBPM12	263,38
M16x2,00	16	14,8	1200	FLUOBM16	259,48	FLUOBPM16	337,68
M20x2,50	18	18,7	800	FLUOBM20	366,28	FLUOBPM20	476,04

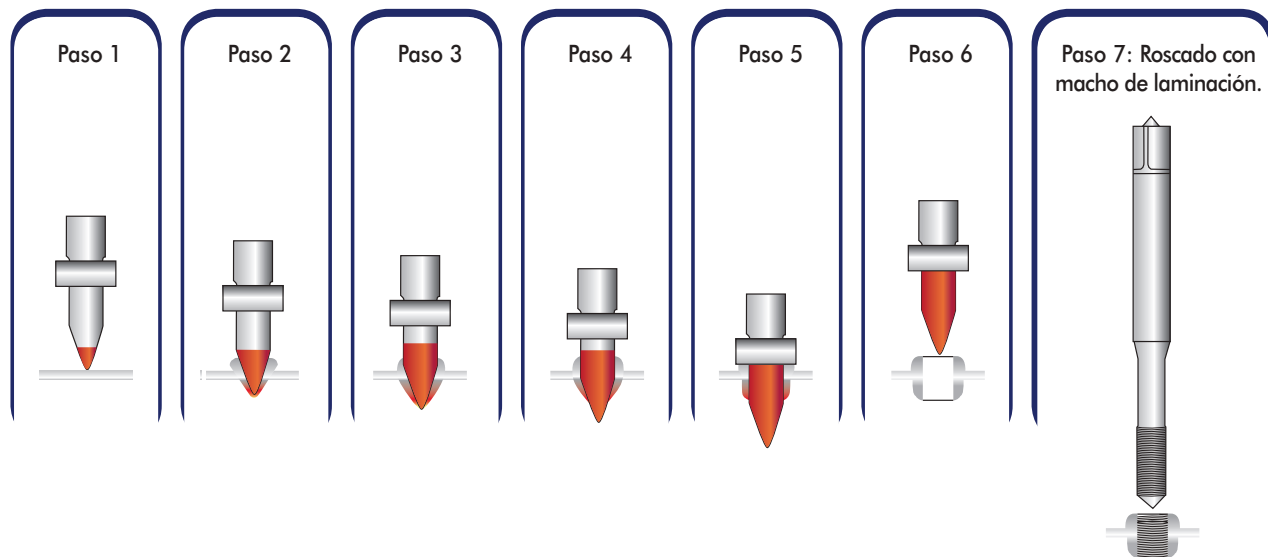

CUT MAGIC PASTY (250ml.y 750ml.)

			PASTY
		UNIDAD DE EMBALAJE	€
ACPU00250	0,250 l.	1 Lata	22,80
ACPU00750	0,750 l.	1 Lata	34,50



Ref. ACPU00250



Ref. ACPU00750

Brocas Metal

Rosa

BROCAS BIDIAMETRALES HSS
MANGO CILÍNDRICO Y MANGO CÓNICO

Ref. BC26

HSS	DIN 8376	180°
-----	----------	------

ASIENTO ALLEN

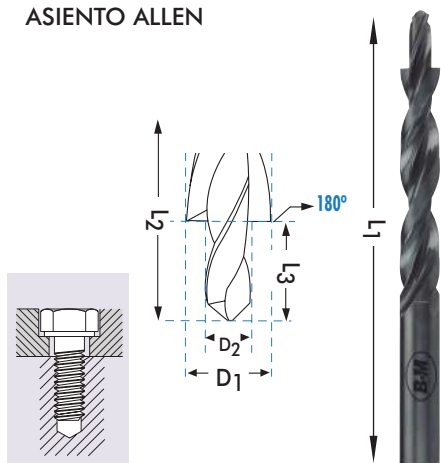

BC26					
	D2 mm	D1 mm	L1 x L2 mm	L3 mm	€
M3	3,4	6	93 x 57	9	50,43
M4	4,5	8	117 x 75	11	52,89
M5	5,5	10	133 x 87	13	62,86
M6	6,6	11	142 x 94	15	71,03
M8	9,0	15	169 x 114	19	87,27
M10	11,0	18	191 x 130	23	173,42

Ref. BC24

HSS	DIN 8374	90°
-----	----------	-----

ASIENTO CÓNICO para tornillos DIN 7991



BC24					
	D2 mm	D1 mm	L1 x L2 mm	L3 mm	€
M3	3,2	6,0	93 x 57	9	58,84
M4	4,3	8,0	117 x 75	11	61,71
M5	5,3	10,0	133 x 87	13	73,34
M6	6,4	11,5	142 x 94	15	83,78
M8	8,4	15,0	169 x 114	19	114,59
M10	10,5	19,0	198 x 135	23	176,94

Ref. BC28

HSS	DIN 8378	90°
-----	----------	-----

Taladro previo al roscado

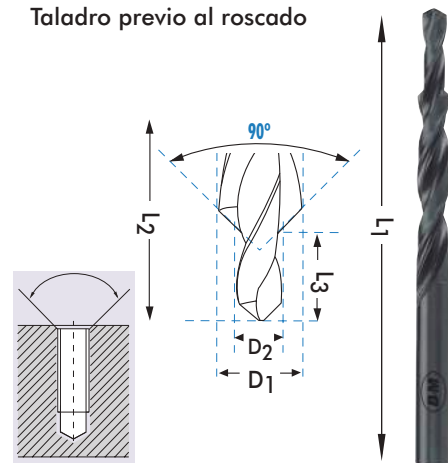

BC28					
	D2 mm	D1 mm	L1 x L2 mm	L3 mm	€
M3	2,5	3,4	70 x 39	8,8	45,24
M4	3,3	4,5	80 x 47	11,8	48,67
M5	4,2	5,5	93 x 57	13,6	52,43
M6	5,0	6,6	101 x 63	16,5	59,65
M8	6,8	9,0	125 x 81	21,0	71,08
M10	8,5	11,0	142 x 94	25,5	82,91
M12	10,2	13,5	160 x 108	30,0	103,23

Ref. BC27

HSS	DIN 8377	180°
-----	----------	------

ASIENTO ALLEN

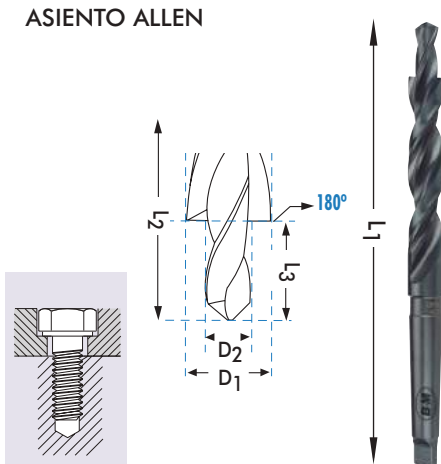

BC27						
	D2 mm	D1 mm	L1 x L2 mm	L3 mm	CM	€
M6	6,6	11	175 x 94	15	1	126,37
M8	9,0	15	212 x 114	19	2	130,50
M10	11,0	18	228 x 130	23	2	147,14
M12	13,5	20	238 x 140	27	2	164,59
M14	15,5	24	281 x 160	31	3	233,40
M16	17,5	26	286 x 165	35	3	332,79
M18	20,0	30	296 x 175	39	3	372,14
M20	22,0	33	334 x 185	43	4	420,79

Ref. BC25

HSS	DIN 8375	90°
-----	----------	-----

ASIENTO CÓNICO para tornillos DIN 7991

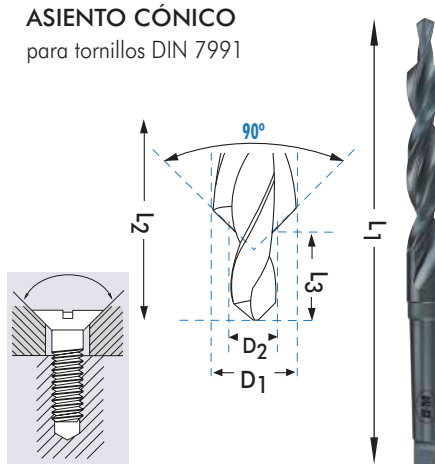

BC25						
	D2 mm	D1 mm	L1 x L2 mm	L3 mm	CM	€
M5	5,5	11,0	175 x 94	13	1	126,24
M6	6,6	13,0	182 x 101	15	1	128,79
M8	9,0	17,2	228 x 130	19	2	153,49
M10	11,0	21,5	248 x 150	23	2	181,72

Ref. BC29

HSS	DIN 8379	90°
-----	----------	-----

Taladro previo al roscado

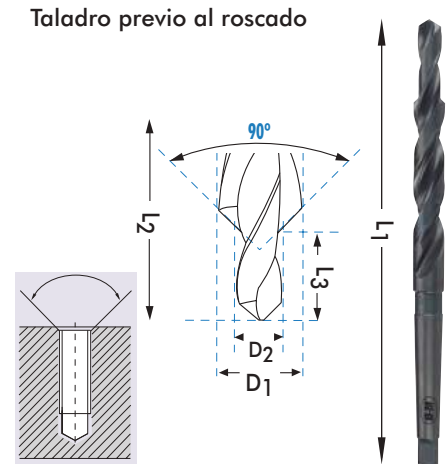

BC29						
	D2 mm	D1 mm	L1 x L2 mm	L3 mm	CM	€
M8	6,8	9,0	162 x 81	21,0	1	115,79
M10	8,5	11,0	175 x 94	25,5	1	126,16
M12	10,2	13,5	189 x 108	30,0	1	149,02
M14	12,0	15,5	218 x 120	34,5	2	159,02
M16	14,0	17,5	228 x 130	38,5	2	171,62
M18	15,5	20,0	238 x 140	43,5	2	191,95
M20	17,5	22,0	248 x 150	47,5	2	232,09

BROCAS EXTRACORTAS BIDIAMETRALES

Ref. BC36

HSSCo 5% **90°**

						BC36
	D1 mm	D2 mm	D3 mm	L1 x L2 mm	L3 mm	€
M3	3,4	2,5	3,4	52 x 20	8	24,49
M4	4,5	3,3	4,5	58 x 24	11	25,65
M5	5,5	4,2	5,5	66 x 28	13	26,82
M6	6,6	5,0	6,6	70 x 31	16	29,15
M8	9,0	6,8	9,0	84 x 40	20	34,98
M10	11,0	8,5	11,0	95 x 47	24	46,06
M12	14,0	10,2	14,0	107 x 54	29	61,80
M14	16,0	12,0	16,0	115 x 56	32	157,41
M16	18,0	14,0	18,0	135 x 60	34	198,22

Ref. BCMD36

MD **90°** **TiAlN**

						BCMD36
	D1 mm	D2 mm	D3 mm	L1 x L2 mm	L3 mm	€
M3	6,0	2,5	6,0	66 x 20	8,8	46,64
M4	6,0	3,3	6,0	66 x 24	11,4	54,41
M5	6,0	4,2	6,0	66 x 28	13,6	58,30
M6	8,0	5,0	8,0	79 x 31	16,5	68,02
M8	10,0	6,8	10,0	89 x 40	21,0	93,28
M10	12,0	8,5	12,0	102 x 47	25,5	126,32
M12	14,0	10,2	14,0	107 x 54	30,0	174,90

Ref. BC74

HSSCo 5% **180°**

						BC74
	D1 mm	D2 mm	D3 mm	L1 x L2 mm	L3 mm	€
M2	4,3	2,4	4,3	45 x 12	6	16,91
M3	6,0	3,4	6,0	45 x 18	9	17,20
M4	8,0	4,5	8,0	50 x 22	11	20,41
M5	10,0	5,5	10,0	55 x 26	13	22,74
M6	11,0	6,6	11,0	63 x 30	15	28,57
M8	15,0	9,0	12,5	100 x 34	19	53,64
M10	18,0	11,0	12,5	110 x 42	23	78,12
M12	20,0	14,0	12,5	110 x 34	28	102,61
M14	24,0	16,0	12,5	120 x 42	34	207,55

Ref. BC34

HSSCo 5% **90°**

						BC34
	D1 mm	D2 mm	D3 mm	L1 x L2 mm	L3 mm	€
M2	4,6	2,2	4,6	45 x 12	6	16,91
M3	6,5	3,2	6,5	45 x 18	9	17,20
M4	8,6	4,3	8,6	50 x 26	11	20,41
M5	10,4	5,3	10,4	55 x 30	13	22,74
M6	12,4	6,4	12,4	63 x 34	15	28,57
M8	16,4	8,4	12,5	100 x 42	19	53,64
M10	20,4	10,5	12,5	110 x 34	23	78,12
M12	25,0	13,0	12,5	120 x 42	28	207,55

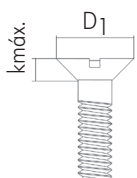

DIN 7991

	M2	M2.5	M3	M4	M5	M6	M8	M10	M12	M14	M16	M18	M20
Kmáx.	1,2	1,5	1,7	2,3	2,8	3,3	4,4	5,5	6,5	7	7,5	8	8,5
D1	4	5	6	8	10	12	16	20	24	27	30	33	36

BROCAS HELICOIDALES CON MANGO CÓNICO DIN 345
**DIN
345**

Realice agujeros previos iguales a un tercio del diámetro final a taladrar.
Ejem: Si va a usar una broca de Ø 30mm, haga un previo de Ø10mm.

			BC11	BC22	BC32	BC21	BC13			
Ø mm	L1 x L2 mm	CM	€	€	€	€	€	€	€	€
10,75	175 x 94	1	30,65							
11,00	175 x 94	1	26,47	80,16			39,67	75,46		
11,25	175 x 94	1	31,99							
11,50	175 x 94	1	27,83	83,48			40,71	75,46		
11,75	175 x 94	1	32,00							
12,00	182 x 101	1	27,98	86,10			30,10	78,78		
12,25	182 x 101	1	35,63							
12,50	182 x 101	1	29,94	90,13			41,99	78,94		
12,75	182 x 101	1	35,64							
13,00	182 x 101	1	31,22	88,20	68,17		42,88	89,86		
13,25	189 x 101	1	39,44							
13,50	189 x 101	1	32,94	115,53	82,39		44,25	89,61		
13,75	189 x 101	1	39,44							
14,00	189 x 108	1	32,97	113,40	78,32		35,54	97,64		
14,25	212 x 114	2	42,71							
14,50	212 x 114	2	37,11	125,49	96,11		59,36	97,62		
14,75	212 x 114	2	42,70							
15,00	212 x 114	2	37,11	115,66	91,36		59,36	110,47		
15,25	218 x 120	2	43,93							
15,50	218 x 120	2	38,20	127,88	94,29		61,10	117,64		
15,75	218 x 120	2	43,93	157,73	117,85					
16,00	218 x 120	2	38,41	121,69	94,29		40,30	117,58		
16,25	223 x 125	2	49,67							
16,50	223 x 125	2	43,41	129,21	100,07		62,34	117,95		
16,75	223 x 125	2	49,67							
17,00	223 x 125	2	43,40	127,27	100,07		62,02	124,96		
17,25	228 x 130	2	55,00							
17,50	228 x 130	2	48,00	134,95	105,86		66,81	124,80		
17,75	228 x 130	2	55,00	184,03	141,41					
18,00	228 x 130	2	46,10	132,38	113,14		46,00	135,07		
18,25	233 x 135	2	60,47							
18,50	233 x 135	2	52,83	145,27	117,49		68,45	157,87		
18,75	233 x 135	2	60,87							
19,00	233 x 135	2	53,01	142,08	117,49		57,61	157,64		
19,25	238 x 140	2	65,84							
19,50	238 x 140	2	57,32	164,18	123,27		73,34	177,04		
19,75	238 x 140	2	66,29							
20,00	238 x 140	2	57,35	158,71	123,27		60,59	177,46		
20,25	243 x 145	2	68,58							
20,50	243 x 145	2	59,44	182,79	143,59		74,45	180,33		
20,75	243 x 145	2	68,58							
21,00	243 x 145	2	59,44	184,85	143,59		74,11	180,33		
21,25	248 x 150	2	75,68							
21,50	248 x 150	2	65,54	208,25	156,64		78,41	196,61		
21,75	248 x 150	2	75,68	269,28	195,81					
22,00	248 x 150	2	65,67	187,81	156,64		70,56	196,61		
22,00*	265 x 150	3	89,27							
22,25	248 x 150	2	82,83							
22,50	253 x 155	2	71,86	232,92	165,34		85,38	196,92		
22,75	253 x 155	2	82,83							
23,00	253 x 155	2	71,70	218,79	179,84		84,76	213,58		
23,25	276 x 155	3	91,35							
23,50	276 x 155	3	79,57	232,45	216,81		102,13	213,44		
23,75	281 x 160	3	91,46							
24,00	281 x 160	3	79,40	235,45	200,16		81,51	234,77		

Cono reforzado, DIN 346, bajo demanda

BROCAS HELICOIDALES CON MANGO CÓNICO DIN 345

DIN
345



Realice agujeros previos iguales a un tercio del diámetro final a taladrar.
Ejem: Si va a usar una broca de Ø 30mm, haga un previo de Ø10mm.

		BC11	BC22	BC32	BC21	BC13
Ø mm	L1 x L2 mm	CM	€	€	€	€
31,00	301x180	3	143,60	363,86		163,34 479,10
31,25	301x180	3	174,74			
31,50	301x180	3	151,00	558,93		
31,75	306x185	3	174,74	440,25	474,99	
32,00	334x185	4	151,26	420,93	379,98	170,91 479,06
32,00	334x185	3	281,67			
32,25	334x185	4	203,94			
32,50	334x185	4	173,75			
32,75	334x185	4	203,94			
33,00	334x185	4	172,71	481,23		186,02 590,39
33,25	334x185	4	213,03			
33,50	334x185	4	188,42			
33,75	339x190	4	214,19			
34,00	339x190	4	187,85	542,22		264,34 594,21
34,25	339x190	4	234,07			
34,50	339x190	4	205,17			
34,75	339x190	4	234,07	589,51	650,81	
35,00	339x190	4	206,19	569,76	520,63	291,46 608,61
35,25	339x190	4	250,87			
35,50	339x190	4	220,10			
35,75	344x195	4	257,59			
36,00	344x195	4	220,65	612,13		302,51 949,76
36,25	344x195	4	270,74			
36,50	344x195	4	233,36			
36,75	344x195	4	270,71			
37,00	344x195	4	233,05	572,13		311,33 1.025,82
37,25	344x195	4	288,54			
37,50	344x195	4	244,20			
37,75	344x195	4	288,54			
38,00	349x200	4	244,76	660,28		320,23 1.074,04
38,25	349x200	4	304,92			
38,50	349x200	4	260,46			
38,75	349x200	4	304,92			
39,00	349x200	4	260,67	675,64		332,22 1.134,35
39,25	349x200	4	306,70			
39,50	349x200	4	276,07			
39,75	349x200	4	306,70			
40,00	349x200	4	275,71	708,02		343,01 1.170,16
40,50	354x205	4	289,02			
41,00	354x205	4	289,38	744,27		
41,50	354x205	4	307,59			
42,00	354x205	4	306,96	779,30		
42,50	354x205	4	322,59			
43,00	359x210	4	322,60	817,14		
43,50	359x210	4	337,76			
44,00	359x210	4	337,97	848,49		
44,50	359x210	4	353,46			
45,00	359x210	4	353,73	887,33		
45,50	364x215	4	367,54			
46,00	364x215	4	366,00	924,17		
46,50	364x215	4	382,55			
47,00	364x215	4	382,36	958,76		
47,50	364x215	4	395,39			
48,00	369x220	4	395,11	998,95		
48,50	369x220	4	411,08			

		BC11	BC22	BC32	BC21	BC13
MATERIAL		HSS	HSSCo 5%	HSSCo 5%	HSS	PMD
AFILADO						
ÁNGULO PUNTA		118°	135°	135°	118°	118°
HÉLICE		30° "N"	30° "N"	38° "S"	30° "N"	30° "N"
ACABADO		OX	OX	BRILLANTE	TiN	BRILLANTE
APLICACIÓN		70 Kg/mm ²	120 Kg/mm ²	INOX	PRODUCCIÓN	FUNDICIÓN
Ø mm	L1 x L2	CM	€	€	€	€
24,25	281x160	3	99,31			
24,50	281x160	3	86,67	251,11	236,35	107,87 234,58
24,75	281x160	3	99,66	248,01	341,87	
25,00	281x160	3	86,31	246,67	185,64	96,17 240,62
25,25	286x165	3	108,68			
25,50	286x165	3	94,45	307,02	277,17	121,81 285,55
25,75	286x165	3	108,39			
26,00	286x165	3	93,91	291,58	234,95	101,03 270,66
26,25	286x165	3	117,37			
26,50	286x165	3	101,67	322,74	277,15	126,38 313,75
26,75	291x170	3	117,37			
27,00	291x170	3	101,77	323,64	252,33	105,85 287,73
27,25	291x170	3	125,62			
27,50	291x170	3	108,85	385,95		132,75 345,63
27,75	291x170	3	125,62	358,34	556,29	
28,00	291x170	3	109,18	358,53	261,08	110,87 319,01
28,25	296x175	3	134,74			
28,50	296x175	3	116,71	397,08		139,39 376,59
28,75	296x175	3	134,76			
29,00	296x175	3	116,69	366,55	284,27	126,75 339,57
29,25	296x175	3	148,16			
29,50	296x175	3	128,51	406,10		166,43 410,77
29,75	296x175	3	148,16	403,44	542,91	
30,00	296x175	3	128,58	372,00	298,75	131,61 360,95
30,25	301x180	3	164,93			
30,50	301x180	3	143,46	538,63		
30,75	301x180	3	165,01			

Cono reforzado, DIN 346, bajo demanda

BROCA HELICOIDAL CON MANGO CÓNICO DIN 345

Ref. BC11

**DIN
345**

OX

HSS

			BC11
Ø mm	L1 x L2 mm	CM	€
49,00	369x220	4	409,35
49,50	369x220	4	422,23
50,00	369x220	4	426,76
50,50	369x220	4	611,09
51,00	412x225	5	500,43
51,50	412x225	5	670,73
52,00	412x225	5	534,83
52,50	412x225	5	687,06
53,00	412x225	5	572,80
53,50	412x225	5	718,72
54,00	417x230	5	630,33
54,50	417x230	5	711,51
55,00	417x230	5	624,00
56,00	417x230	5	702,12
57,00	422x235	5	745,90
58,00	422x235	5	752,27
59,00	422x235	5	774,86
60,00	422x235	5	733,50
61,00	427x240	5	860,36
62,00	427x240	5	896,09
63,00	427x240	5	947,65
64,00	432x245	5	999,84
65,00	432x245	5	957,35
66,00	432x245	5	1.079,37
67,00	432x245	5	1.114,17
68,00	437x250	5	1.143,07
69,00	437x250	5	1.178,61
70,00	437x250	5	1.117,51
71,00	437x250	5	1.290,20
72,00	442x255	5	1.316,92
73,00	442x255	5	1.351,39
74,00	442x255	5	1.390,94
75,00	442x255	5	1.310,22
76,00	447x260	5	1.542,79
77,00	514x260	6	1.655,60
78,00	514x260	6	1.687,95
79,00	514x260	6	1.721,96
80,00	514x260	6	1.816,36
81,00	519x265	6	2.000,45
82,00	519x265	6	2.050,44
83,00	519x265	6	2.089,77
84,00	519x265	6	2.134,13
85,00	519x265	6	2.186,85
86,00	524x270	6	2.234,59
87,00	524x270	6	2.282,05
88,00	524x270	6	2.340,70
89,00	524x270	6	2.386,01
90,00	524x270	6	2.454,29
91,00	529x275	6	2.588,57
92,00	529x275	6	2.603,49
93,00	529x275	6	2.696,33
94,00	529x275	6	2.751,12
95,00	529x275	6	2.807,65
96,00	534x280	6	2.900,14
97,00	534x280	6	2.924,47
98,00	534x280	6	2.989,71
99,00	534x280	6	3.043,77
100,00	534x280	6	3.101,84



Ref. BC11350MC

EXPOSITOR 25 BROCAS MANGO CÓNICO
BC11350MC

Cono Morse n° 1	14 1									DIN 345
n° 2	14,50 1	15 1	15,50 1	16 1	16,50 1	17 1	17,50 1	18 1	18,50 1	
n° 3	19 1	19,5 1	20 1	20,5 1	21 1	21,5 1	22 1	22,5 1	23 1	

Dimensiones:

ancho 260 x fondo 200 x alto 280 mm

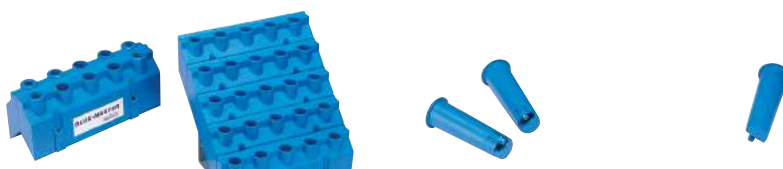
1.707,81€
EXPOSITORES VACÍOS PARA BROCAS CON MANGO CÓNICO

REFERENCIA	D9351MC	D0350MC	D9352MC	D9353MC
Nº BROCAS	10	25	1	1
DIMENSIONES	260x105x80 mm	260x280x200 mm	Reductor CONO MORSE 1	Reductor CONO MORSE 2
P.V.P. €	112,98	379,12	19,39	19,39

*El precio del expositor vacío incluye los reductores necesarios para mangos CONO MORSE 1 y CONO MORSE 2

RECARGOS POR REBAJAR MANGOS CÓNICOS

n° 2-1

n° 2-0

n° 3-2

n° 3-1

n° 4-3

n° 4-2

n° 5-4

n° 5-3

n° 6-5

n° 6-4

€ NETO
48,34
72,50

BROCA MANGO CÓNICO PARA TALADRADO DE MATERIALES Duros Y RESISTENTES

Ref. BC73

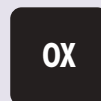
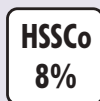

Broca especial para HARDOX 450

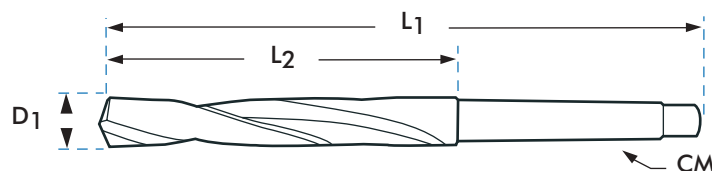

	BC73				
	D1 mm	L1 mm	L2 mm	CM	€
BC731000	10,00	175	76	2	47,36
BC731020	10,20	175	76	2	47,36
BC731100	11,00	175	76	2	47,36
BC731200	12,00	179	81	2	51,87
BC731250	12,50	179	81	2	51,87
BC731300	13,00	179	81	2	51,87
BC731400	14,00	184	86	2	55,22
BC731450	14,50	187	89	2	55,94
BC731500	15,00	187	89	2	56,30
BC731550	15,50	187	89	2	63,95
BC731600	16,00	187	89	2	66,99
BC731650	16,50	190	92	2	70,09
BC731700	17,00	190	92	2	71,41
BC731800	18,00	190	92	2	72,49
BC731850	18,50	213	95	3	80,79
BC731900	19,00	213	95	3	82,36
BC732000	20,00	213	95	3	87,56
BC732100	21,00	219	102	3	95,36
BC732200	22,00	222	105	3	109,63
BC732400	24,00	222	105	3	118,10
BC732500	25,00	225	108	3	139,95
BC732600	26,00	270	124	4	165,83
BC732700	27,00	270	124	4	178,34
BC732800	28,00	270	124	4	185,18
BC733000	30,00	270	124	4	205,98
BC733200	32,00	280	133	4	239,73
BC733500	35,00	292	136	4	299,54
BC733600	36,00	292	146	4	315,04
BC734000	40,00	298	152	4	396,05
BC734500	45,00	298	152	4	538,64
BC735000	50,00	356	152	5	632,78

Realice agujeros previos iguales a un tercio del diámetro final a taladrar.
Ej.: Si va a usar una broca de Ø 30mm, haga un previo de Ø10mm.

CONDICIONES DE CORTE

MATERIAL	ACERO 30-40 HRc		ACERO 40-44 HRc	
	Vc:13-16 (R.PM)	AVANCE (mm/rev)	Vc:10-13 (R.PM)	AVANCE (mm/rev)
10	450	0,10	350	0,10
12	390	0,10	290	0,10
15	300	0,10	230	0,10
25	180	0,14	140	0,14
30	150	0,16	120	0,16
35	130	0,19	100	0,19
40	110	0,22	90	0,22
50	90	0,22	70	0,22

BROCAS HELICOIDALES CON MANGO CÓNICO SERIE LARGA

Brocas Metal

Rosa

**DIN
341**

Ref. BC12



Ref. BC56



			BC12	BC56				BC12	BC56				BC12	BC56
MATERIAL			HSS	HSSCo 5%	Ø mm	L1 x L2	CM	€	€	Ø mm	L1 x L2	CM	€	€
AFILADO					14,00	223x142	1	37,20	93,54	27,00	343x222	3	124,46	301,44
ÁNGULO PUNTA					14,25	245x147	2	62,47		27,50	343x222	3	160,39	
HÉLICE					14,50	245x147	2	46,81		28,00	343x222	3	142,06	310,31
ACABADO			OX	BRILLANTE	14,75	245x147	2	62,47		28,50	351x230	3	190,35	
APLICACIÓN					15,00	245x147	2	46,81	108,62	29,00	351x230	3	155,56	336,93
Ø mm	L1 x L2	CM	€	€	15,25	251x153	2	61,85		29,50	351x230	3	190,52	
5,00	155x74	1	19,63		15,50	251x153	2	45,93	113,04	30,00	351x230	3	159,54	354,65
5,50	161x80	1	26,32		15,75	251x153	2	64,14		30,50	360x239	3	217,84	
6,00	161x80	1	20,88		16,00	251x153	2	47,64	113,04	31,00	360x239	3	201,48	398,98
6,50	167x86	1	21,32		16,25	257x159	2	69,77		31,50	360x239	3	233,68	
7,00	174x93	1	22,64		16,50	257x159	2	51,79	119,71	32,00	397x248	4	202,28	443,32
7,50	174x93	1	23,81		16,75	257x159	2	69,77		32,50	397x248	4	256,08	
8,00	181x100	1	24,22		17,00	257x159	2	51,79	119,71	33,00	397x248	4	215,55	
8,50	181x100	1	24,22		17,25	263x165	2	68,28		33,50	397x248	4	252,84	
9,00	188x107	1	26,72		17,50	263x165	2	55,04	126,35	34,00	406x257	4	262,37	
9,50	188x107	1	29,23		17,75	263x165	2	77,63		34,50	406x257	4	277,81	
10,00	197x116	1	30,10	63,16	18,00	263x165	2	57,63	135,22	35,00	406x257	4	263,95	
10,25	197x116	1	36,02		18,25	269x171	2	77,94		35,50	406x257	4	277,81	
10,50	197x116	1	31,31		18,50	269x171	2	62,55	140,74	36,00	416x267	4	303,71	
10,75	197x116	1	45,90		18,75	269x171	2	80,45		36,50	416x267	4	384,35	
11,00	206x125	1	30,10	69,16	19,00	269x171	2	60,82	140,74	37,00	416x267	4	327,12	
11,25	206x125	1	45,90		19,25	275x177	2	84,42		37,50	416x267	4	380,88	
11,50	206x125	1	30,10		19,50	275x177	2	68,36	146,73	38,00	426x277	4	342,47	
11,75	206x125	1	41,43		19,75	275x177	2	85,46		38,50	426x277	4	434,14	
12,00	215x134	1	32,19	77,78	20,00	275x177	2	65,21	146,73	39,00	426x277	4	355,81	
12,25	215x134	1	41,43		20,50	282x184	2	79,08	170,68	39,50	426x277	4	434,14	
12,50	215x134	1	33,02		21,00	282x184	2	74,82	170,68	40,00	426x277	4	384,82	
12,75	215x134	1	44,45		21,50	289x191	2	90,26	186,19	41,00	436x287	4	492,05	
13,00	215x134	1	33,02	81,36	22,00	289x191	2	85,17	186,19	42,00	436x287	4	513,23	
13,25	223x142	1	46,34		22,50	296x198	2	93,07	197,27	43,00	447x298	4	546,21	
13,50	223x142	1	35,99		23,00	296x198	2	85,21	212,80	44,00	447x298	4	554,53	
13,75	223x142	1	50,06		23,50	319x198	3	108,36	219,43	45,00	447x298	4	584,45	
					24,00	327x206	3	109,38	239,39	46,00	459x310	4	614,96	
					24,50	327x206	3	116,18	248,26	47,00	459x310	4	647,22	
					25,00	327x206	3	109,36	232,75	48,00	470x321	4	676,52	
					25,50	335x214	3	131,89		49,00	470x321	4	698,63	
					26,00	335x214	3	115,30	274,86	50,00	470x321	4	723,30	
					26,50	335x214	3	136,05		55,00	505x310	5	945,78	

* Consultar otras longitudes especiales disponibles bajo demanda.

BROCAS HELICOIDALES CON MANGO CÓNICO SERIE EXTRALARGA



Ref. BC14



Ref. BC41

			BC14	BC41				BC14	BC41				BC14	BC41
MATERIAL			HSS	HSSCo 5%	Ø mm	L1 x L2	CM	€	€	Ø mm	L1 x L2	CM	€	€
AFILADO					ÁNGULO PUNTA					HÉLICE				
ACABADO			OX	BRILLANTE	APLICACIÓN			70 Kg/mm²	120 Kg/mm²					
Ø mm	L1 x L2	CM	€	€				€	€				€	€
8,00	265x165	1	67,56		17,00	355x230	2	160,86	282,91	29,00	460x305	3	375,77	878,54
8,00	330x210	1	84,21		17,00	445x295	2	193,41	395,45	29,00	580x385	3	538,78	1.192,53
8,50	265x165	1	74,19		17,50	370x245	2	177,01	318,19	29,50	460x305	3	389,05	1.005,78
8,50	330x210	1	86,09		17,50	465x310	2	212,97	430,31	29,50	580x385	3	543,23	1.387,94
9,00	275x175	1	76,37		18,00	370x245	2	177,01	309,65	30,00	460x305	3	389,05	919,13
9,00	345x220	1	97,07		18,00	465x310	2	212,97	408,08	30,00	580x385	3	543,23	1.239,71
9,50	275x175	1	81,72		18,50	370x245	2	192,03	357,81	30,50	480x320	4		1.124,50
9,50	345x220	1	98,12		18,50	465x310	2	230,17	488,25	30,50	610x410	4		
10,00	285x185	1	83,96		19,00	370x245	2	191,93	356,97	31,00	480x320	4	436,09	1.163,26
10,00	360x235	1	103,56		19,00	465x310	2	230,17	455,77	31,00	610x410	4	579,15	
10,50	285x185	1	89,17		19,50	385x260	2	204,98	399,22	32,00	505x320	4	455,97	
10,50	360x235	1	106,73		19,50	490x325	2	249,09	511,21	32,00	635x410	4	607,68	
11,00	300x195	1	93,09		20,00	385x260	2	204,94	392,22	33,00	505x320	4	496,86	
11,00	375x250	1	110,70		20,00	490x325	2	249,09	510,94	33,00	635x410	4	672,73	
11,50	300x195	1	101,94		20,50	385x260	2	232,09	522,04	34,00	530x340	4	538,75	
11,50	375x250	1	127,32		20,50	490x325	2	278,70	601,10	34,00	665x430	4	698,05	
12,00	310x205	1	104,33		21,00	385x260	2	232,09	479,45	35,00	530x340	4	554,91	
12,00	395x260	1	130,00		21,00	490x325	2	278,70	595,63	35,00	665x430	4	758,57	
12,50	310x205	1	111,03		21,50	405x270	2	247,51	564,70	36,00	530x340	4	598,66	
12,50	395x260	1	145,09		21,50	515x345	2	299,10	705,37	36,00	665x430	4	796,54	
13,00	310x205	1	111,03	248,30	22,00	405x270	2	247,51	512,05	37,00	530x340	4	613,80	
13,00	395x260	1	145,09		22,00	515x345	2	299,10	687,61	37,00	665x430	4	885,03	
13,50	425x220	1	121,55		22,50	405x270	2	282,05	601,10	38,00	555x360	4	669,55	
13,50	410x275	1	149,01		22,50	515x345	2	337,65	746,55	38,00	695x460	4	937,20	
14,00	325x220	1	121,59	237,01	23,00	405x270	2	282,05	586,24	39,00	555x360	4	697,81	
14,00	410x275	1	149,01	332,05	23,00	515x345	2	337,65	705,37	39,00	695x460	4	981,91	
14,50	340x220	2	133,16	259,27	23,50	425x270	3	309,90	734,64	40,00	555x360	4	735,62	
14,50	425x275	2	162,28	364,08	23,50	535x345	3	375,77	896,03	40,00	695x460	4	936,60	
15,00	340x220	2	133,16	249,06	24,00	440x290	3	309,90	670,81	41,00	555x360	4	827,70	
15,00	425x275	2	162,28	353,62	24,00	555x365	3	375,77	820,85	41,00	695x460	4	1.064,55	
15,50	355x230	2	149,27	289,65	24,50	440x290	3	321,16	792,60	42,00	555x360	4	854,97	
15,50	445x295	2	178,99	390,27	24,50	555x365	3	396,03	942,09	42,00	695x460	4	1.136,63	
16,00	355x230	2	149,27	275,08	25,00	440x290	3	321,16	706,93	43,00	585x385	4	891,59	
16,00	445x295	2	178,99	380,35	25,00	555x365	3	396,03	842,57	43,00	735x490	4	1.159,76	
16,50	355x230	2	160,71	289,65	25,50	440x290	3	331,95	843,40	44,00	585x385	4	933,69	
16,50	445x295	2	193,41	394,74	25,50	555x365	3	437,48	1.098,31	44,00	735x490	4	1.200,52	
					26,00	440x290	3	331,95	764,32	45,00	585x385	4	961,75	
					26,00	555x365	3	437,48	988,29	45,00	735x490	4	1.256,44	
					26,50	440x290	3	339,93	856,43	46,00	585x385	4	991,15	
					26,50	555x365	3	451,37	1.179,20	46,00	735x490	4	1.312,61	
					27,00	460x305	3	339,93	794,41	47,00	585x385	4	1.073,73	
					27,00	580x385	3	451,37	1.046,10	47,00	735x490	4	1.377,04	
					27,50	460x305	3	362,62	931,75	48,00	605x405	4	1.074,19	
					27,50	580x385	3	488,29	1.248,66	48,00	765x510	4	1.457,14	
					28,00	460x305	3	362,62	841,59	49,00	605x405	4	1.106,90	
					28,00	580x385	3	488,29	1.136,81	49,00	765x510	4	1.512,61	
					28,50	460x305	3	375,77	988,56	50,00	605x405	4	1.139,48	
					28,50	580x385	3	538,78	1.300,45	50,00	765x510	4	1.552,15	

BROCA CON MANGO CÓNICO HSS CON REFRIGERACIÓN INTERIOR

Ref. BC87

 $\leq 10xD$

HSS

DIN
341

118°

30°
"N"

OX

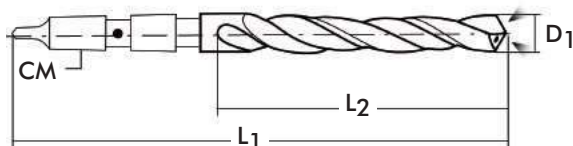
 AFILADO ESPECIAL 170°
 CON PUNTA PILOTO
 CENTRADO PRECISO

					BC87
	D1 mm	L1 mm	L2 mm	CM	€
BC871000	10,0	214	116	2	388,11
BC871050	10,5	214	116	2	393,44
BC871100	11,0	223	125	2	393,44
BC871150	11,5	223	125	2	402,05
BC871200	12,0	232	134	2	402,05
BC871250	12,5	232	134	2	402,05
BC871300	13,0	232	134	2	402,05
BC871350	13,5	240	142	2	402,05
BC871400	14,0	240	142	2	402,05
BC871450	14,5	245	147	2	415,75
BC871500	15,0	245	147	2	415,75
BC871550	15,5	251	153	2	429,72
BC871600	16,0	251	153	2	429,72
BC871650	16,5	257	159	2	429,72
BC871700	17,0	257	159	2	429,72
BC871750	17,5	263	165	2	457,10
BC871800	18,0	263	165	2	457,10
BC871850	18,5	292	171	3	471,16
BC871900	19,0	292	171	3	471,16
BC871950	19,5	298	177	3	498,80
BC872000	20,0	298	177	3	498,80
BC872050	20,5	305	184	3	526,70
BC872100	21,0	305	184	3	526,70
BC872150	21,5	312	191	3	559,68
BC872200	22,0	312	191	3	559,68
BC872250	22,5	319	198	3	554,33
BC872300	23,0	319	198	3	554,33

					BC87
	D1 mm	L1 mm	L2 mm	CM	€
BC872350	23,5	319	198	3	554,33
BC872400	24,0	327	206	3	554,33
BC872450	24,5	327	206	3	565,80
BC872500	25,0	327	206	3	565,80
BC872550	25,5	335	214	3	623,82
BC872600	26,0	335	214	3	623,82
BC872650	26,5	335	214	3	651,46
BC872700	27,0	371	222	4	651,46
BC872750	27,5	371	222	4	714,99
BC872800	28,0	371	222	4	714,99
BC872850	28,5	379	230	4	762,52
BC872900	29,0	379	230	4	762,52
BC872950	29,5	379	230	4	815,02
BC873000	30,0	379	230	4	815,02
BC873050	30,5	379	230	4	970,20
BC873100	31,0	388	239	4	970,20
BC873150	31,5	388	239	4	970,20
BC873200	32,0	397	248	4	970,20
BC873300	33,0	397	248	4	1.133,65
BC873400	34,0	406	257	4	1.133,65
BC873500	35,0	406	257	4	1.274,91
BC873600	36,0	406	257	4	1.274,91
BC873700	37,0	406	257	4	1.441,24
BC873800	38,0	426	277	4	1.441,24
BC873900	39,0	426	277	4	1.607,70
BC874000	40,0	426	277	4	1.607,70

BROCAS EN ESTUCHES DE METAL Y PLÁSTICO

Brocas Metal

Rosa

Gris

**DIN
338**

HSS

(Brocas Ref. BC2)



REFERENCIA	D0010	D0011	P6010	P6011
Nº BROCAS	19	25	19	25
CALIDAD	HSS	HSS	HSS	HSS
CONTENIDO	Ø 1-10 x 0,50 mm	Ø 1-13 x 0,50 mm	Ø 1-10 x 0,50 mm	Ø 1-13 x 0,50 mm
P.V.P. €	52,54	109,31	52,54	109,31

Plus

(Brocas Ref. BC02)



REFERENCIA	DP010	DP011	PP6010	PP6011
Nº BROCAS	19	25	19	25
CALIDAD	Plus	Plus	Plus	Plus
CONTENIDO	Ø 1-10 x 0,50 mm	Ø 1-13 x 0,50 mm	Ø 1-10 x 0,50 mm	Ø 1-13 x 0,50 mm
P.V.P. €	59,40	122,89	59,40	122,89

**HSSCo
5%**

(Brocas Ref. BC5)



REFERENCIA	DC010	DC011	PC6010	PC6011
Nº BROCAS	19	25	19	25
CALIDAD	HSSCo	HSSCo	HSSCo	HSSCo
CONTENIDO	Ø 1-10 x 0,50 mm	Ø 1-13 x 0,50 mm	Ø 1-10 x 0,50 mm	Ø 1-13 x 0,50 mm
P.V.P. €	87,80	205,91	87,80	205,91

HSS

TiN

(Brocas Ref. BC18)



REFERENCIA	DT010	DT011	PT6010	PT6011
Nº BROCAS	19	25	19	25
CALIDAD	HSS+TiN	HSS+TiN	HSS+TiN	HSS+TiN
CONTENIDO	Ø 1-10 x 0,50 mm	Ø 1-13 x 0,50 mm	Ø 1-10 x 0,50 mm	Ø 1-13 x 0,50 mm
P.V.P. €	77,56	169,64	77,56	169,64

BROCAS EN ESTUCHE METÁLICOS (cuartos y décimas)
**DIN
338**
HSS

(Brocas Ref. BC2)

REFERENCIA	AD001	AD002	D0014	D0015
Nº BROCAS	37	49	50	41
CALIDAD	HSS	HSS	HSS	HSS
CONTENIDO	∅ 1-10 x 0,25 mm	∅ 1-13 x 0,25 mm	∅ 1-5,90 x 0,10 mm	∅ 6-10 x 0,10 mm
P.V.P. €	143,15	256,92	100,39	261,34

Plus

(Brocas Ref. BC02)

REFERENCIA	ADP01	ADP02		
Nº BROCAS	37	49	50	41
CALIDAD	<i>Plus</i>	<i>Plus</i>	<i>Plus</i>	<i>Plus</i>
CONTENIDO	∅ 1-10 x 0,25 mm	∅ 1-13 x 0,25 mm	∅ 1-5,90 x 0,10 mm	∅ 6-10 x 0,10 mm
P.V.P. €	171,52	305,15		

 ESTE ESTUCHE
SE SUMINISTRA
BAJO DEMANDA

 ESTE ESTUCHE
SE SUMINISTRA
BAJO DEMANDA

**HSSCo
5%**

(Brocas Ref. BC5)

REFERENCIA	ADC01	ADC02	DC014	DC015
Nº BROCAS	37	49	50	41
CALIDAD	HSSCo	HSSCo	HSSCo	HSSCo
CONTENIDO	∅ 1-10 x 0,25 mm	∅ 1-13 x 0,25 mm	∅ 1-5,90 x 0,10 mm	∅ 6-10 x 0,10 mm
P.V.P. €	207,01	463,31	152,54	387,14

HSS
TiN

(Brocas Ref. BC18)

REFERENCIA	ADT01	ADT02		
Nº BROCAS	37	49	50	41
CALIDAD	HSS+TiN	HSS+TiN	HSS+TiN	HSS+TiN
CONTENIDO	∅ 1-10 x 0,25 mm	∅ 1-13 x 0,25 mm	∅ 1-5,90 x 0,10 mm	∅ 6-10 x 0,10 mm
P.V.P. €	176,76	361,10		

 ESTE ESTUCHE
SE SUMINISTRA
BAJO DEMANDA

 ESTE ESTUCHE
SE SUMINISTRA
BAJO DEMANDA

BROCAS EN ESTUCHES METÁLICOS (previos y décimas)

Brocas Metal
Gris
Rosa

DIN 338

HSS

(Brocas Ref. BC2)



REFERENCIA	D0022	D0017	D0035	D0007
Nº BROCAS	81	23	29	10
CALIDAD	HSS	HSS	HSS	HSS
CONTENIDO	∅ 2-10 x 0,10 mm	∅ 1-10 x 0,50 + ∅ previos*	∅ 1-13 x 0,50 + ∅ previos*	∅ 1-10 x 1 mm
P.V.P. €	447,88	100,15	165,54	42,76

Plus

(Brocas Ref. BC02)

ESTE ESTUCHE SE SUMINISTRA BAJO DEMANDA



REFERENCIA		DP017	DP035	DP007
Nº BROCAS	81	23	29	10
CALIDAD	<i>Plus</i>	<i>Plus</i>	<i>Plus</i>	<i>Plus</i>
CONTENIDO	∅ 2-10 x 0,10 mm	∅ 1-10 x 0,50 + ∅ previos*	∅ 1-13 x 0,50 + ∅ previos*	∅ 1-10 x 1 mm
P.V.P. €		100,30	172,53	56,11

HSSCo 5%

(Brocas Ref. BC5)



REFERENCIA	DC022	DC017	DC035	DC007
Nº BROCAS	81	23	29	10
CALIDAD	HSSCo	HSSCo	HSSCo	HSSCo
CONTENIDO	∅ 2-10 x 0,10 mm	∅ 1-10 x 0,50 + ∅ previos*	∅ 1-13 x 0,50 + ∅ previos*	∅ 1-10 x 1 mm
P.V.P. €	611,95	140,56	269,28	73,06

HSS

TiN

(Brocas Ref. BC18)

ESTE ESTUCHE SE SUMINISTRA BAJO DEMANDA

ESTE ESTUCHE SE SUMINISTRA BAJO DEMANDA

ESTE ESTUCHE SE SUMINISTRA BAJO DEMANDA



REFERENCIA				DT007
Nº BROCAS	81	23	29	10
CALIDAD	HSS+TiN	HSS+TiN	HSS+TiN	HSS+TiN
CONTENIDO	∅ 2-10 x 0,10 mm	∅ 1-10 x 0,50 + ∅ previos*	∅ 1-13 x 0,50 + ∅ previos*	∅ 1-10 x 1 mm
P.V.P. €				60,68

* Previos: de M3 a M12 (∅3,30 - ∅4,20 - ∅6,80 - ∅10,20)

BROCAS EN ESTUCHES METÁLICOS (Composiciones adicionales)
**DIN
338**
HSS
BRILLANTE

**HSSCo
8%**
(Brocas Ref. BC82)

REFERENCIA	D8210	D8211
Nº BROCAS	19	25
CALIDAD	HSS	HSS
CONTENIDO	∅ 1-10 x 0,50 mm	∅ 1-13 x 0,50 mm
P.V.P. €	52,83	107,75

(Brocas Ref. BC58)

REFERENCIA	DC810	DC811
Nº BROCAS	19	25
CALIDAD	HSSCo 8%	HSSCo 8%
CONTENIDO	∅ 1-10 x 0,50 mm	∅ 1-13 x 0,50 mm
P.V.P. €	127,04	299,72

(Brocas Ref. BC95)

REFERENCIA	DC9510	DC9511
Nº BROCAS	19	25
CALIDAD	HSSCo	HSSCo
CONTENIDO	∅ 1-10 x 0,50 mm	∅ 1-13 x 0,50 mm
P.V.P. €	98,24	222,07

JUEGOS DE 13 BROCAS DIN 338
**DIN
338**
HSS
Plus
**HSSCo
5%**
TiN

(Brocas Ref. BC2)

(Brocas Ref. BC02)

(Brocas Ref. BC5)

(Brocas Ref. BC18)

REFERENCIA	D0009	DP009	DC009	DT009
Nº BROCAS	13	13	13	13
CALIDAD	HSS	<i>Plus</i>	HSSCo	HSS+TiN
CONTENIDO	∅ 1,5-6,5x0,5(+3,2 & 4,8) mm	∅ 1,5-6,5x0,5(+3,2 & 4,8) mm	∅ 1,5-6,5x0,5(+3,2 & 4,8) mm	∅ 1,5-6,5x0,5(+3,2 & 4,8) mm
P.V.P. €	20,30	23,87	35,58	31,74

(Brocas Ref. BC2)
(Brocas Ref. BC02)
(Brocas Ref. BC5)
(Brocas Ref. BC18)

REFERENCIA	D0008	DP008	DC008	DT008
Nº BROCAS	13	13	13	13
CALIDAD	HSS	<i>Plus</i>	HSSCo	HSS+TiN
CONTENIDO	∅ 1 - 7 x 0,50 mm	∅ 1 - 7 x 0,50 mm	∅ 1 - 7 x 0,50 mm	∅ 1 - 7 x 0,50 mm
P.V.P. €	21,12	23,91	37,28	34,71

BROCAS EN ESTUCHES METÁLICOS (Composiciones adicionales)
JUEGOS DE 12 BROCAS DIN 338

	DIN 338	HSS	<i>Plus</i>	HSSCo 5%	TiN	HSSCo 8%
		(Brocas Ref. BC2)	(Brocas Ref. BC02)	(Brocas Ref. BC5)	(Brocas Ref. BC18)	(Brocas Ref. BC58)
REFERENCIA	D0006	DP006	DC006	DT006	DC806	
Nº BROCAS	12	12	12	12	12	12
CALIDAD	HSS	<i>Plus</i>	HSSCo	HSS+TiN	HSSCo 8%	
CONTENIDO	Ø 2-7x0,50 + 8 mm	Ø 2-7x0,50 + 8 mm	Ø 2-7x0,50 + 8 mm	Ø 2-7x0,50 + 8 mm	Ø 2-7x0,50 + 8 mm	Ø 2-7x0,50 + 8 mm
P.V.P. €	38,77	40,12	55,88	50,78	73,63	

BROCAS SERIE LARGA DIN 340

	DIN 340	HSS	HSSCo 5%	TiN
				
		(Brocas Ref. BC4)	(Brocas Ref. BC47)	(Brocas Ref. BC40)
REFERENCIA	D0004	DC004	DT004	
Nº BROCAS	19	17	18	
CALIDAD	HSS	HSSCo	HSS+TiN	
CONTENIDO	Ø 1-10 x 0,50 mm	Ø 2-10 x 0,50 mm	Ø 1,5 -10 x 0,50 mm	
P.V.P. €	90,79	193,28	139,85	

BROCAS SERIE EXTRACORTA DIN 1897

	DIN 1897	HSS	HSSCo 5%	HSSCo 5%	PMD	MD
		(Brocas Ref. BC3)	(Brocas Ref. BC31)	(Brocas Ref. BC33)	(Brocas Ref. BC77)	(Brocas Ref. BC43)
REFERENCIA	D3010	D3110	D3310	D7710	D4310	
Nº BROCAS	19	19	19	17	17	
CALIDAD	HSS	HSSCo	HSSCo "S"	Punta Metal Duro	Metal Duro Integral	
CONTENIDO	Ø 1-10 x 0,50 mm	Ø 1-10 x 0,50 mm	Ø 1-10 x 0,50 mm	Ø 2-10 x 0,50 mm	Ø 2-10 x 0,50 mm	
P.V.P. €	61,04	91,52	166,80	424,21	631,06	



	(Brocas Ref. BC3)	(Brocas Ref. BC31)	(Brocas Ref. BC33)	(Brocas Ref. BC77)	(Brocas Ref. BC43)
REFERENCIA	D3011	D3111	D3311	D7711	D4311
Nº BROCAS	25	25	25	23	23
CALIDAD	HSS	HSSCo	HSSCo "S"	Punta Metal Duro	Metal Duro Integral
CONTENIDO	Ø 1-13 x 0,50 mm	Ø 1-13 x 0,50 mm	Ø 1-13 x 0,50 mm	Ø 2-13 x 0,50 mm	Ø 2-13 x 0,50 mm
P.V.P. €	117,05	192,30	301,88	710,21	1.341,77

BROCAS EN ESTUCHES METÁLICOS (Composiciones especiales)
BROCAS HSS PARA ALUMINIO
BROCAS HSSCo CON GEOMETRÍA TIPO "S"
DIN
338
HSS **Al**

(Brocas Ref. BC16)



REFERENCIA	D16010	D16011
Nº BROCAS	19	25
CALIDAD	HSS	HSS
CONTENIDO	∅ 1-10 x 0,50 mm	∅ 1-13 x 0,50 mm
P.V.P. €	83,19	182,51

DIN
338
HSSCo
5% **INOX**

(Brocas Ref. BC55)



REFERENCIA	D55010	D55011
Nº BROCAS	18	24
CALIDAD	HSSCo	HSSCo
CONTENIDO	∅ 1,50-10 x 0,50 mm	∅ 1,50-13 x 0,50 mm
P.V.P. €	169,98	387,06

BROCAS CON PUNTA DE METAL DURO PARA ACEROS TRATADOS, FUNDICIÓN, ETC.
BROCAS DE METAL DURO INTEGRAL PARA MATERIALES MUY DUROS
DIN
338
PMD **FUNDICIÓN**

(Brocas Ref. BC7)



REFERENCIA	DPMD010	DPMD011
Nº BROCAS	17	23
CALIDAD	Punta Metal Duro	Punta Metal Duro
CONTENIDO	∅ 2-10 x 0,50 mm	∅ 2-13 x 0,50 mm
P.V.P. €	341,93	588,39

DIN
338
MD **ALTA PRODUCCIÓN**

(Brocas Ref. BC42)



REFERENCIA	D42010	D42011
Nº BROCAS	17	23
CALIDAD	Metal Duro Integral	Metal Duro Integral
CONTENIDO	∅ 2-10 x 0,50 mm	∅ 2-13 x 0,50 mm
P.V.P. €	936,18	2.119,61

JUEGOS DE BROCAS HSSCo 8%
DIN
338
HSSCo
8%

(Brocas Ref. BC58)



REFERENCIA	ADC81	ADC82	D89380
Nº BROCAS	37	49	19
CALIDAD	HSSCo 8%	HSSCo 8%	HSSCo 8%
CONTENIDO	∅ 1-10 x 0,25 mm	∅ 1-13 x 0,25 mm	∅ 1-10 x 0,50 mm
P.V.P. €	292,76	686,96	120,94

REFERENCIA	DC807	DC817	DC835
Nº BROCAS	10	23	29
CALIDAD	HSSCo 8%	HSSCo 8%	HSSCo 8%
CONTENIDO	∅ 1-10 x 1 mm	∅ 1-10 x 0,50 mm + previos*	∅ 1-13 x 0,50 mm + previos*
P.V.P. €	92,53	188,52	370,70

* Previos: M3-M12: ∅3,30 ∅4,20 ∅6,80 ∅10,20

BROCAS EN ESTUCHES METÁLICOS (Composiciones especiales)

BROCAS ESPECIALES PARA ACERO INOXIDABLE



(Brocas Ref. BC50)

REFERENCIA	D50010	D50011
Nº BROCAS	19	25
CALIDAD	HSSCo	HSSCo
CONTENIDO	Ø 1-10 x 0,50 mm	Ø 1-13 x 0,50 mm
P.V.P. €	296,07	509,15

BROCAS CON CORTE IZQUIERDA



(Brocas Ref. BC15)

REFERENCIA	D0010I	D0011I	DR9312I
Nº BROCAS	19	25	10
CALIDAD	HSS	HSS	HSS
CONTENIDO	Ø 1-10 x 0,50 mm	Ø 1-13 x 0,50 mm	Ø 1-10 x 1 mm
P.V.P. €	154,54	325,73	76,82

ESTUCHES METÁLICOS

ESTUCHES VACÍOS

REFERENCIA	D0010V	D0011V	AD001V
Nº BROCAS	19	25	37
CONTENIDO	Ø 1-10 x 0,50 mm	Ø 1-13 x 0,50 mm	Ø 1-10 x 0,25 mm
P.V.P. €	16,29	22,72	59,69



REFERENCIA	AD002V	D0014V	D0015V	D0022V	D0006V
Nº BROCAS	49	50	41	81	12
CONTENIDO	Ø 1-13 x 0,25 mm	Ø 1-5,9 x 0,10 mm	Ø 6-10 x 0,10 mm	Ø 2-10 x 0,10 mm	Ø 2-7x0,50 + 8 mm
P.V.P. €	69,32	52,87	105,63	202,59	22,10

REFERENCIA	D0007V	D0017V	D0035V	DE10V (Extra corta)	DE11V (Extra corta)
Nº BROCAS	10	23	29	19	25
CONTENIDO	Ø 1-10 x 1 mm	Ø 1-10 x 0,50 mm+previos*	Ø 1-13 x 0,50 mm+previos*	Ø 1-10 x 0,50 mm	Ø 1-13 x 0,50 mm
P.V.P. €	37,92	43,98	62,20	38,47	47,00

* Previos: de M3 a M12 (Ø3,30 - Ø4,20 - Ø6,80 - Ø10,20)

JUEGOS DE BROCAS EN ESTUCHES DE PLÁSTICO RECTIFICADAS MICROBROCAS, AEROMODELISMO Y MARQUETERÍA



Ref. DR9120

REFERENCIA	DR9120	DC9120	DR9102
Nº BROCAS	10	10	15
CALIDAD	HSS	HSSCo5%	HSS
CONTENIDO	Ø 1-1,90 x 0,10 mm	Ø 1-1,90 x 0,10 mm	Ø 0,30 - 0,35 - 0,40 - 0,45 - 0,50 - 0,55 - 0,60 - 0,65 - 0,70 - 0,75 - 0,80 - 0,85 - 0,90 - 0,95 - 1
P.V.P. €	20,51	30,93	41,14

BROCAS EN ESTUCHES DE PLÁSTICO
**DIN
338**
HSS

(Brocas Ref. BC2)



REFERENCIA	DR9314	DR9312	DR9313	DR9311
Nº BROCAS	6	10	13	19
CALIDAD	HSS	HSS	HSS	HSS
CONTENIDO	Ø 2-3-4-5-6-8 mm	Ø 1-10 x 1 mm	Ø 2-8 x 0,50 mm	Ø 1-10 x 0,50 mm
P.V.P. €	14,47	30,81	30,57	53,83

Plus

(Brocas Ref. BC02)



REFERENCIA	DP9314	DP9312	DP9313	DP9311
Nº BROCAS	6	10	13	19
CALIDAD	Plus	Plus	Plus	Plus
CONTENIDO	Ø 2-3-4-5-6-8 mm	Ø 1-10 x 1 mm	Ø 2-8 x 0,50 mm	Ø 1-10 x 0,50 mm
P.V.P. €	15,25	33,36	32,60	58,84

**HSSCo
5%**

(Brocas Ref. BC5)



REFERENCIA	DC9314	DC9312	DC9313	DC9311
Nº BROCAS	6	10	13	19
CALIDAD	HSSCo	HSSCo	HSSCo	HSSCo
CONTENIDO	Ø 2-3-4-5-6-8 mm	Ø 1-10 x 1 mm	Ø 2-8 x 0,50 mm	Ø 1-10 x 0,50 mm
P.V.P. €	23,00	49,33	49,69	88,17

HSS
TiN

(Brocas Ref. BC18)



REFERENCIA	DT9314	DT9312	DT9313	DT9311
Nº BROCAS	6	10	13	19
CALIDAD	HSS+TiN	HSS+TiN	HSS+TiN	HSS+TiN
CONTENIDO	Ø 2-3-4-5-6-8 mm	Ø 1-10 x 1 mm	Ø 2-8 x 0,50 mm	Ø 1-10 x 0,50 mm
P.V.P. €	16,75	35,66	35,38	62,29

BROCAS EN ESTUCHES PLÁSTICO (Composiciones especiales)

HSS **BRILLANTE**

(Brocas Ref. BC82)



REFERENCIA	D829314	D829312	D829313	D829311
Nº BROCAS	6	10	13	19
CALIDAD	HSS	HSS	HSS	HSS
CONTENIDO	Ø 2-3-4-5-6-8 mm	Ø 1-10 x 1 mm	Ø 2-8 x 0,50 mm	Ø 1-10 x 0,50 mm
P.V.P. €	14,47	30,81	30,57	53,83

HSSCo
8%

(Brocas Ref. BC58)



REFERENCIA	D89314	D89312	D89313	D89311
Nº BROCAS	6	10	13	19
CALIDAD	HSSCo 8%	HSSCo 8%	HSSCo 8%	HSSCo 8%
CONTENIDO	Ø 2-3-4-5-6-8 mm	Ø 1-10 x 1 mm	Ø 2-8 x 0,50 mm	Ø 1-10 x 0,50 mm
P.V.P. €	31,01	66,32	67,97	119,24

BOTES CLASIFICADORES DE PLÁSTICO DE 19 PIEZAS

DIN
338

HSS

Plus

HSSCo
5%

TiN



(Brocas Ref. BC2)

(Brocas Ref. BC02)

(Brocas Ref. BC5)

(Brocas Ref. BC18)

REFERENCIA	DR9380	DP9380	DC9380	DT9380
Nº BROCAS	19	19	19	19
CALIDAD	HSS	<i>Plus</i>	HSSCo	HSS+TiN
CONTENIDO	Ø 1-10 x 0,50 mm	Ø 1-10 x 0,50 mm	Ø 1-10 x 0,50 mm	Ø 1-10 x 0,50 mm
P.V.P. €	53,33	59,78	88,92	79,03

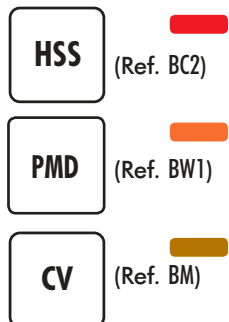
ESTUCHES DE PLÁSTICO MIXTOS: HSS, WIDIA Y MADERA
SERIE STANDARD

REFERENCIA	EC9330	EC9331	EC9332	EC9382
Nº BROCAS	8	9	9	18
CALIDAD				
CONTENIDO	Ø 4 - 5 - 6 - 8 mm x 2	Ø 4 - 6 - 8 mm x 3	Ø 5 - 6 - 8 mm x 3	Ø 3-4-5-6-8-10 mm x 3
P.V.P. €	18,58	19,80	20,19	38,21

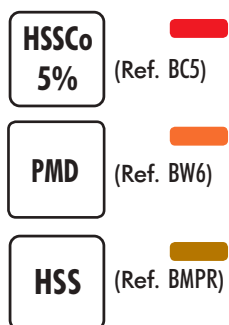
SERIE PROFESIONAL

REFERENCIA	M9330	M9331	M9332	M9382
Nº BROCAS	8	9	9	18
CALIDAD				
CONTENIDO	Ø 4 - 5 - 6 - 8 mm x 2	Ø 4 - 6 - 8 mm x 3	Ø 5 - 6 - 8 mm x 3	Ø 3-4-5-6-8-10 mm x 3
P.V.P. €	32,10	31,52	32,16	62,88

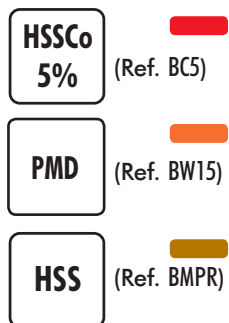
SERIE EXTRA PROFESIONAL

REFERENCIA	P9330	P9331	P9332	P9382
Nº BROCAS	8	9	9	18
CALIDAD				
CONTENIDO	Ø 4 - 5 - 6 - 8 mm x 2	Ø 4 - 6 - 8 mm x 3	Ø 5 - 6 - 8 mm x 3	Ø 3-4-5-6-8-10 mm x 3
P.V.P. €	47,65	43,49	44,29	88,50

MALETAS METÁLICAS DE BROCAS RECTIFICADAS



DIN
338

125 BROCAS Ø 1-10 mm x 0,50

Ø	1	1,50	2	2,50	3	3,50	4	4,50
Pcs	10	5	10	5	10	5	10	5
	5	5,50	6	6,50	7	7,50	8	8,50
	10	5	10	5	5	5	5	5
	9	9,50	10	= 125 BROCAS				
	5	5	5					



REFERENCIA	BC2880	BC02880	BC5880	BC18880	M0880V
Nº BROCAS	125	125	125	125	250
CALIDAD	HSS	Plus	HSSCo 5%	HSS TIN	
CONTENIDO	Ø 1-10x0,50 S/DETALLE	Ø 1-10x0,50 S/DETALLE	Ø 1-10x0,50 S/DETALLE	Ø 1-10x0,50 S/DETALLE	ESTUCHE VACÍO
P.V.P. €	321,25	360,10	531,77	459,73	129,83



DIN
338

155 BROCAS Ø 1-13 mm x 0,50

Ø	1	1,50	2	2,50	3	3,50	4	4,50	5
Pcs	10	5	10	5	10	5	10	5	10
	5,50	6	6,50	7	7,50	8	8,50	9	9,50
	5	10	5	5	5	5	5	5	5
	10	10,50	11	11,50	12	12,50	13	= 155 BROCAS	
	5	5	5	5	5	5	5		



REFERENCIA	BC2881	BC02881	BC5881	BC18881	M0881V
Nº BROCAS	155	155	155	155	290
CALIDAD	HSS	Plus	HSSCo 5%	HSS TIN	
CONTENIDO	Ø 1-13x0,50 S/DETALLE	Ø 1-13x0,50 S/DETALLE	Ø 1-13x0,50 S/DETALLE	Ø 1-13x0,50 S/DETALLE	ESTUCHE VACÍO
P.V.P. €	645,26	717,18	1.145,06	936,62	300,65

MALETINES METÁLICOS DE BROCAS CÓNICAS DIN 345

DIN
345

HSS



(Brocas Ref. BC11)

REFERENCIA	MBC11-1	MBC11-2
Nº BROCAS	10	10
CALIDAD	HSS	HSS
CONTENIDO	Ø 14 - 15 - 16 - 17 - 18 - 19 - 20 - 21 - 22 - 23	Ø 14 - 16 - 18 - 20 - 22 - 24 - 25 - 26 - 28 - 30
P.V.P. €	589,00	821,71

IMPLANTACIÓN EN SUMINISTROS INDUSTRIALES ESPECIALIZADOS

Brocas Metal

Gris



Ref. FL01

Dimensiones: ancho 1000 x fondo 400 x alto 2200 mm

EXPOSITOR FL01**BROCAS CILÍNDRICAS DIN 338**DIN
338**BC2**

HSS

BC02

Plus

BC5HSSCo
5%

Composición: Gama y cantidades para cada referencia.

Ø	2	2,25	2,50	2,75	3	3,25	3,50	3,75	4	4,25	4,50
Cant.	100	50	100	30	100	50	50	30	100	50	50

4,75	5	5,25	5,50	5,75	6	6,25	6,50	6,75	7	7,25
30	100	50	50	50	80	20	50	20	50	20

7,50	7,75	8	8,25	8,50	8,75	9	9,25	9,50	9,75	10	10,50
30	20	60	20	30	20	50	10	20	10	60	20

1º Bandeja

BROCAS CILÍNDRICAS DIN 338DIN
338**BC2**

HSS

BC02

Plus

BC5HSSCo
5%

Composición:

Ø	11	11,50	12	12,50	13	14
Cant.	12	6	12	6	6	6

BROCAS CILÍNDRICAS DIN 338**BC9**DIN
338

12,70

HSS

Composición:

Ø	14	14,50	15	15,50	16	16,50	17	18	19	20
Cant.	6	2	6	2	6	2	3	4	2	3

2º Bandeja

BROCAS CÓNICAS DIN 345**BC11**DIN
345

HSS

Composición:

10	10,50	11	11,50	12	12,50	13	13,50	14	14,50	15	15,50
4	2	4	2	4	2	4	2	4	2	4	2

16	16,50	17	17,50	18	18,50	19	19,50	20	20,50	21	21,50
4	2	4	2	4	2	4	2	4	2	3	1

22	22,50	23	23,50
3	1	2	1

3º Bandeja

BROCAS CÓNICAS DIN 345**BC11**DIN
345

HSS

Composición:

24	24,50	25	25,50	26	26,50	27	27,50	28
2	1	2	1	2	1	2	1	2

28,50	29	30	31	32	35	40	45	50
1	1	2	1	2	1	1	1	1

24.513,81 €

**EXPOSITORES POLIVALENTES DE GANCHOS REGULABLES ADAPTABLES
A EXPOSITORES VERTICALES PARA COLGAR Y DE SOBREMESA**

Brocas Metal

Gris

EXPOSITOR DE BROCAS HSS EN PETACA

1-44



Composición: Brocas BC2

Ø	8,50	9	9,50	10				
Cant.	10	20	10	30				
	6	6,50	7	7,50	8			
	40	30	30	30	30			
	2	2,50	3	3,50	4	4,50	5	5,50
	50	50	50	50	50	50	50	30

Ref. 1-44 **1.312,50 €**



Dimensiones: ancho 330 x fondo 360 x alto 515 mm



EXPOSITOR DE BROCAS HSS-G Plus EN PETACA

1-46



Composición: Brocas BC02

Ø	8,50	9	9,50	10				
Cant.	10	20	10	30				
	6	6,50	7	7,50	8			
	40	20	30	20	30			
	2	2,50	3	3,50	4	4,50	5	5,50
	50	50	50	50	50	50	50	30

Ref. 1-46 **1.402,80 €**

Dimensiones: ancho 330 x fondo 360 x alto 515 mm

EXPOSITOR DE BROCAS HSSCo EN PETACA

1-45



Composición: Brocas BC5

Ø	8,50	9	9,50	10				
Cant.	10	20	10	20				
	6	6,50	7	7,50	8			
	30	20	30	20	30			
	2	2,50	3	3,50	4	4,50	5	5,50
	50	50	50	50	50	50	50	30

Ref. 1-45 **2.107,10 €**



Dimensiones: ancho 330 x fondo 360 x alto 515 mm

EXPOSITORES DE TIPO MEDIO PARA LA PRESENTACIÓN DE BROCAS CILÍNDRICAS DIN 338
EXPOSITOR DE BROCAS HSS EN PETACA
3-1

 Composición: Brocas **BC2**

Ø	2	2,50	3	3,25	3,50	4
Cant.	100	50	100	50	50	100
	4,25	4,50	5	5,25	5,50	5,75
	50	50	100	50	50	50
	6	6,50	6,75	7	7,50	8
	50	50	20	50	30	40
	8,50	9	9,50	10	10,50	
	20	40	20	40	10	
	11	11,50	12	12,50	13	14
	12	12	12	6	6	6

Ref. 3-1

3.069,16 €

Dimensiones: ancho 400 x fondo 240 x alto 815 mm



Dimensiones: ancho 400 x fondo 240 x alto 815 mm

EXPOSITOR DE BROCAS HSS-G Plus EN PETACA
3-2

 Composición: Brocas **BC02**

Ø	2	2,50	3	3,25	3,50	4
Cant.	100	50	100	50	50	100
	4,25	4,50	5	5,25	5,50	5,75
	50	50	100	50	50	50
	6	6,50	6,75	7	7,50	8
	50	50	20	50	30	40
	8,50	9	9,50	10	10,50	
	20	40	20	40	10	
	11	11,50	12	12,50	13	14
	12	12	12	6	6	6

Ref. 3-2

3.434,12 €

EXPOSITOR DE BROCAS HSSCo EN PETACA
3-3

 Composición: Brocas **BC5**

Ø	2	2,50	3	3,25	3,50	4
Cant.	100	50	100	30	30	100
	4,25	4,50	5	5,25	5,50	5,75
	30	30	100	20	30	30
	6	6,50	6,75	7	7,50	8
	50	20	20	30	20	30
	8,50	9	9,50	10	10,50	
	10	30	10	30	10	
	11	11,50	12	12,50	13	14
	12	12	12	6	6	6

Ref. 3-3

4.393,22 €

Dimensiones: ancho 400 x fondo 240 x alto 815 mm



TABLA DE CONSULTA DE VELOCIDADES Y AVANCES PARA BROCAS

			DIÁMETRO Ø (mm)											
			2	3	5	7	10	12	15	18	20	22	25	30
ACERO BLANDO 70 kg/mm ² BC2	V/C	RPM	3979	2653	1592	1137	796	663	531	442	398	362	318	265
	25 m/min	mm / vuelta	0,04	0,06	0,08	0,15	0,20	0,26	0,30	0,33	0,34	0,35	0,35	0,39
		S (mm / min)	159	159	127	171	159	172	159	146	135	127	111	103
ACERO TRATADO 120 kg/mm ² BC5	V/C	RPM	2069	1379	828	591	414	345	276	230	207	188	166	138
	13 m/min	mm / vuelta	0,03	0,045	0,06	0,10	0,15	0,18	0,20	0,22	0,23	0,25	0,25	0,28
		S (mm / min)	62	62	50	59	62	60	55	51	48	47	41	39
INOXIDABLE BC50	V/C	RPM	1751	1167	700	500	350	292	233	195	175	159	140	117
	11 m/min	mm / vuelta	0,02	0,05	0,08	0,14	0,19	0,23	0,25	0,27	0,28	0,30	0,31	0,33
		S (mm / min)	35	58	56	70	67	67	58	53	49	48	43	39
ALUMINIO BC16	V/C	RPM	7958	5305	3183	2274	1592	1326	1061	884	796	723	637	531
	50 m/min	mm / vuelta	0,03	0,06	0,08	0,16	0,20	0,23	0,25	0,28	0,29	0,30	0,30	0,36
		S (mm / min)	239	318	255	364	318	305	265	248	231	217	191	191
TITANIO BC42	V/C	RPM	5570	3714	2228	1592	1114	928	743	619	557	506	446	371
	18 m/min	mm / vuelta	0,02	0,03	0,03	0,05	0,08	0,08	0,12	0,15				
		S (mm / min)	111	111	67	80	84	74	89	93				
FUNDICIÓN BC7	V/C	RPM	3979	2653	1592	1137	796	663	531	442	398	362	318	265
	25 m/min	mm / vuelta	0,05	0,08	0,10	0,20	0,27	0,31	0,37	0,41	0,42	0,42	0,42	0,45
		S (mm / min)	199	199	159	227	215	206	196	181	167	152	134	119
LATÓN BC66	V/C	RPM	7958	5305	3183	2274	1592	1326	1061	884	796	723	637	531
	50 m/min	mm / vuelta	0,04	0,07	0,08	0,17	0,21	0,25	0,28	0,28	0,30	0,30	0,33	0,40
		S (mm / min)	318	345	239	387	334	332	297	248	239	217	210	212
PLÁSTICO FIBRA DE CARBONO BC7	V/C	RPM	1911	1274	764	546	382	318	255	212	191	174	153	127
	12 m/min	mm / vuelta	0,02	0,03	0,03	0,05	0,08	0,08	0,12	0,15				
		S (mm / min)	38	38	23	27	29	25	31	32				
ALEACIONES NI BC42	V/C	RPM	4775	3183	1910	1364	955	796	637	531	477	434	382	318
	30 m/min	mm / vuelta	0,015	0,02	0,02	0,03	0,04	0,06	0,07	0,08	0,11	0,12	0,15	
		S (mm / min)	72	64	42	34	38	48	45	42	53	52	57	
CIRCUITOS IMPRESOS BC79	25	RPM	3979	-	-	-	-	-	-	-	-	-	-	-

OBSERVACIONES:

- Conocidos el diámetro de la broca y el material a taladrar, la velocidad y el avance se identifican rápidamente.

Ejemplo;

Material: Aluminio

Ø de broca: 7 mm

RPM=2274

S=364 mm/min

- Tras realizar los primeros orificios es necesario ajustar tanto la velocidad como el avance.

INFORMACIÓN TÉCNICA SOBRE DIMENSIONES DE CONOS MORSE DIN 228D

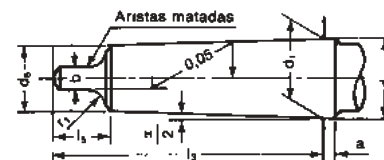

CONO MORSE	Adelgazamiento	Ø 2	a	b h13	d ₁	d ₂ Ø mayor =	d ₆ Ø menor =	d ₇ Dimen. máx.	l ₃ -1	l ₄ Dimen. máx.	l ₅ Dimen. máx.	r ₁	r ₂
0	1:19,212=0,05205	1°29 27"	3,0	3,9	9,045	9,2	6,1	6,0	56,5	59,5	10,5	4	1,0
1	1:20,047=0,04988	1°25 43"	3,5	5,2	12,065	12,2	9,0	8,7	62,0	65,5	13,5	5	1,2
2	1:20,020=0,04995	1°25 50"	5,0	6,3	17,780	18,0	14,0	13,5	75,0	80,0	16,0	6	1,6
3	1:19,922=0,05020	1°26 16"	5,0	7,0	23,825	24,1	19,1	18,5	94,0	99,0	20,0	7	2,0
4	1:19,254=0,05194	1°29 15"	6,5	11,9	31,267	31,6	25,2	24,5	117,5	124,0	24,0	8	2,5
5	1:19,002=0,05263	1°30 26"	6,5	15,9	44,399	44,7	36,5	35,7	149,5	156,0	29,0	10	3,0
6	1:19,180=0,05214	1°29 36"	8,0	19,0	63,348	63,8	52,4	51,0	210,0	218,0	40,0	10	4,0

AMPLIA GAMA DE ESTUCHES PARA BROCAS

Ref. DP011

Ref. DT010

► Metal Clásico

Caja metálica alta resistencia

► Plástico Azul

Rígido, Robusto y Ligero

Ventana transparente

Plástico reforzado con goma antichoque



Ref. P6010

Ref. PT6011



Ref. PP6010

Ref. PC011



Ref. PP010

► Plástico Negro

Ligero, manejable .

Plástico reforzado con goma

Alta resistencia y durabilidad